

CVI3

CVI3 Function

V 1.7.2.X

User manual



Model	Part number
CVI3 Function	6159326900

TABLE OF CONTENTS

1 - SAFETY INSTRUCTIONS	6	5 - MONITORING	13
1.1 - General instructions	6	5.1 - Pset/Assembly Process selection	13
1.2 - Personal safety.....	6	5.1.1 - First selection	13
1.2.1 - Differential circuit breaker	6	5.1.2 - Control mode.....	13
1.2.2 - Power consumption.....	6	5.2 - Last result.....	13
1.2.3 - Power supply.....	6	5.3 - Report details	13
1.3 - Tool use hazards	6	5.4 - Monitoring symbols	13
1.4 - Tool care and service	6	5.5 - Trend symbols.....	14
2 - GETTING STARTED.....	7	6 - RESULTS.....	14
2.1 - Front panel	7	6.1 - Display of the last result	14
2.2 - LEDs color code	7	6.2 - Display of other results.....	14
2.3 - Bottom panel	7	6.3 - Display of run reverse results.....	14
2.4 - On receiving the controller	8	7 - MAINTENANCE.....	15
2.5 - Installation	8	7.1 - Controller.....	15
2.6 - Changing the controller language	8	7.1.1 - USB key - Firmware upgrade.....	15
3 - TREE VIEW.....	9	7.1.2 - USB key - Save logs	15
4 - CONTROLLER SETTINGS	9	7.1.3 - USB key - Save config	15
4.1 - Using icons and keyboards	9	7.1.4 - USB key - Save results	15
4.2 - Secondary controller in a workgroup.....	9	7.1.5 - USB key - Advanced diagnostic.....	15
4.3 - Network	10	7.1.6 - CVILOGIX	16
4.4 - Ping	10	7.1.7 - Memory	16
4.5 - Fieldbus.....	10	7.2 - ePOD.....	16
4.6 - Customized protocol.....	11	7.2.1 - Backup/Restore.....	16
4.7 - Date & time.....	11	7.2.2 - Eject	17
4.8 - Beep.....	11	7.2.3 - Repair.....	17
4.9 - Zoom in Control mode.....	11	7.2.4 - Erase results	17
4.10 - Input/Output (reading only).....	12	7.3 - User information	17
4.11 - Access manager.....	12	7.4 - Firmware version.....	17
		8 - APPENDIX - I/O AND EVENTS	18
		8.1 - Logical outputs	18
		8.2 - Logical inputs	23

9 - APPENDIX - USER INFO CODES27

10 - APPENDIX - CONNECTIONS 33

10.1 - Tool connector 33
10.2 - CVI II adaptor 33
10.3 - RS232 - SubD 9pt 34
10.4 - Digital inputs (0 – 24V)..... 34
10.5 - Digital outputs (0 – 24V)..... 34
10.6 - Tightening flow chart and timing chart..... 35
10.7 - Synchronizing single-channel controllers 37
10.8 - Synchronizing TWINCVI3 controllers 37
10.9 - eBUS (for accessories) 38
10.10 - Workgroup..... 38

**11 - APPENDIX - SPARE PARTS - CVI3
FUNCTION..... 39**

**12 - APPENDIX A - CONTROLLER POWER
CONSUMPTION: CURRENT INLET .40**

**13 - APPENDIX B - JVL6-32 RESIDUAL
CURRENT CIRCUIT BREAKER41**

14 - APPENDIX - ePOD.....42

Original instructions.

© Copyright 2016, Desoutter HP2 7SJ UK

All rights reserved. Any unauthorized use or copying of the contents or part thereof is prohibited. This applies in particular to trademarks, model denominations, part numbers and drawings. Use only authorized parts. Any damage or malfunction caused by the use of unauthorised parts is not covered by Warranty or Product Liability.

1 - SAFETY INSTRUCTIONS

1.1 - General instructions



To reduce risk of injury, everyone using, installing, repairing, maintaining, changing accessories on, or working near this tool must read and understand the safety instructions before performing any such task.

Failure to follow all instructions listed below may result in electric shock, fire and / or serious personal injury.

- Refer to the following booklets:
 - General safety instructions, part no. 6159931790
 - Quick-start user manual, part no. 6159932290.



SAVE THESE INSTRUCTIONS CAREFULLY.

1.2 - Personal safety



WARNING: This power tool must be earthed.

If the power tool is not earthed, the system will disable the power stage and the tool will not start. The error message "Bad tool ground" will be displayed.

1.2.1 - Differential circuit breaker

The controller has a residual current circuit breaker with over-current protection fitted with a differential circuit-breaker for user protection. Any insulation defect in the cable or in the tool is detected by this device.

The circuit breaker protects from a leakage current exceeding 30 mA in 50 µs by automatic power cutoff. The device protects the operator from any electric shock and protects, the controller from the deterioration. To make sure that the detection of leakage current is functioning properly, the device must be tested monthly by pushing the yellow pushbutton.

It also has a fuse function. It protects the system from any short-circuit by automatic power cutoff.



- Refer to Appendix B - JVL6-32.

The circuit breaker must be switched on to restart the controller.

1.2.2 - Power consumption

The decision to install an external differential circuit-breaker depends on the type of internal electric network in the customer's plant.

This device detects any insulation defect between one of the phases of the network and the earth, immediately stops the tool by automatic power cutoff and protects the operator from any electric shock.

Should circuit-breakers be installed at line head, we recommend that you select equipment with the following specifications:

- Single-phased 240V 16A - curve D
- Single-phased 110V 32A - curve D.



- Refer to Appendix A: Controller Power consumption: Current inlet.

For information:

- standby consumption is 17 W.
- the max power available supplied via the 24Volt power supply (between pin 2 and 3 on I/O connector):
 - CVI3 Vision or CVI3 Function: 1 A (24V)
 - TWINCVI3: 2 A (24V).

1.2.3 - Power supply

- Only use the cord supplied with the controller to connect to the mains power supply.
- Do not modify the cord or use it for any other purpose.
- Only use genuine Desoutter replacement parts.
- Failure to follow these instructions may result in electric shock.

1.3 - Tool use hazards

The selection of the tool takes account of the operating conditions as stated by the user.

When selected, they must not exceed the operating limits as specified by the manufacturer.

Any excessive internal temperature of the tool electric motor is detected and stops the tool. The motor can start again only after the temperature has decreased.

Motor temperature limits are different for handheld tools and for fixed tools:

- 60°C for handheld tools.
- 100°C for fixed tools.

Although our cables are designed to work under drastic conditions, we recommend that you check the following points for a longer service life:

- Bending radius should not be lower than 10 times the cable diameter.
- Friction with the outer sheath should be restricted.
- Any direct pull on the cable should be avoided.

1.4 - Tool care and service

Only experienced and qualified personnel (authorized electricians) are entitled to open and have access to the inside of the controller.

- If in doubt, return the tool to a Desoutter-authorized service centre. Contact your Desoutter representative for support.
- Disconnect from power supply and wait 10 minutes before starting service operations.



Failure to wait 10 minutes may result in electric shock from not yet unloaded capacitors.



According to Directive 2012/19/CE concerning Waste Electrical and Electronic Equipment (WEEE), this product must be recycled.



- Contact your Desoutter representative or consult the website "www.desouttertools.com" to find out where you can recycle this product.

2 - GETTING STARTED

2.1 - Front panel

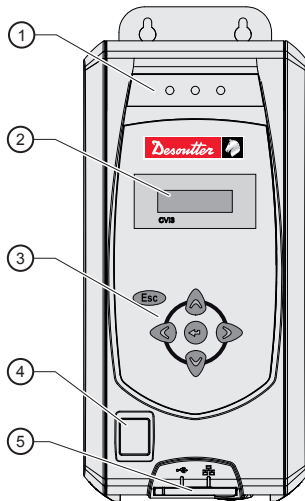

Legend

- 1 Report LEDs
- 2 122 x 32 full graphic display
- 3 Keypad
- 4 On / Off switch
- 5 Dedicated PC software port + USB port

2.2 - LEDs color code

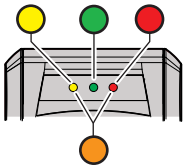

LED color	Designation	Action
Green	Accept report	-
Yellow	Incomplete rundown	Tighten again
Orange	Reject report	Loosen and tighten again
Red	Above High Angle	Remove and replace fastener.

2.3 - Bottom panel

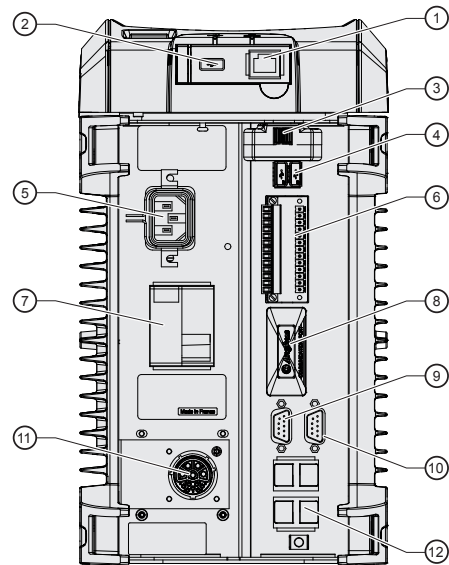

Legend

- 1 Ethernet port dedicated only to PC software
- 2 USB port for data transfer / firmware updating / access control management
- 3 ePOD port for controller backup, memory extension, customer features activation, workgroup configuration.
- 4 2 USB ports to connect barcode readers
- 5 Auto-sensing input voltage mains connector
- 6 2x8 I/O connector dedicated to customer use + 2 quick stops.
- 7 Ground Fault Interruptor: earth fault and overcurrent protection
- 8 Fieldbus port for plug & play Fieldbus modules
- 9 eBUS to daisy-chain up to 15 accessories (e.g. socket tray)
- 10 RS232 port (2 serial ports) to connect: Barcode reader / Delta measuring unit
- 11 8-pin tool connector
- 12 4 Ethernet ports for 1 or 2 networks:
 - 1 network

1	2
3	4

 • Plug the Ethernet cable into any port.
 - 2 networks

1	2
3	4

 Ethernet network 1
 Ethernet network 2

 • Refer to "Appendix - CVI3 connections" to get more information.

 • For more information about installing Fieldbus modules, refer to the "Quick start user manual" part no. 6159931440 at <http://resource-center.desouttertools.com>.

2.4 - On receiving the controller

- Check the following items are included in the kit supplied with the controller.

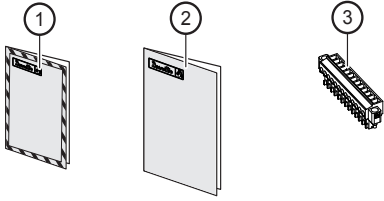

Legend

- 1 Safety booklet
- 2 Quick start user manual
- 3 2 cable clamps

2.5 - Installation

- To install and power the controller, follow the instructions listed in the Quick-start user manual 6159932290 supplied in the controller box.



The controller should be installed in such a way that it should be easily switched off.

When the controller is powered on, the Desoutter logo is displayed and the LEDs are blinking.

- Wait for a few seconds while the firmware is being initialized.

The monitoring screen is displayed:



2.6 - Changing the controller language



Esc

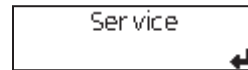
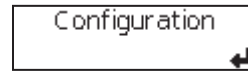
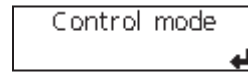

- Keep pressing this key up to the following screen.

- Keep pressing this key up to the following screen.

- Press any key. The name of the language is blinking.

- Select the language.

- Validate

3 - TREE VIEW

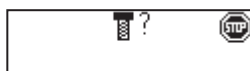

The controller is waiting for the selection of a Pset or Assembly Process.

The tool is locked.

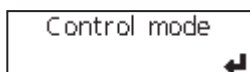

- to display the last result.
- to select the next Assembly Process and/or Pset.

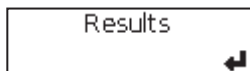

- to display the results.

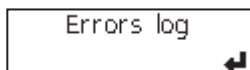

- to display the user info codes.



- to save the results, the configurations and the logs on a USB key.
- to upgrade the firmware.



- to backup/restore/erase the results from the ePOD..
- to eject the ePOD
- to repair the ePOD



- to erase the results, the user info codes and the Pset/ AP configuration from the controller.



- to launch a CVILOGIX program.



- to set up the network.
- to customize the controller.
- to set up the role of the controller in the workgroup.

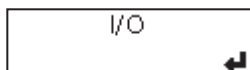

- to display the status of the Input/Output.

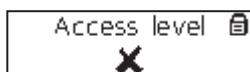

- to enable/disable the data protection of the controller.

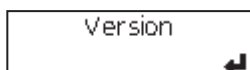

- to display the controller firmware version.

4 - CONTROLLER SETTINGS



- Use CVI CONFIG software to create Psets and Assembly Processes.

4.1 - Using icons and keyboards



to quit without changing



to validate



to navigate



to change



Pset symbol



Assembly Process symbol



- Select a Pset or an Assembly Process.



- The tool is locked.
- Select a Pset or an Assembly Process



The screen is locked.



The screen is unlocked.

- Refer to chapter "Access manager".

4.2 - Secondary controller in a workgroup

A workgroup is a system designed to drive from 2 to 14 fixtured tools with cable connection.

The controller can be selected as one of the secondary controllers of the workgroup.

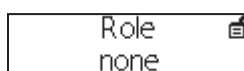
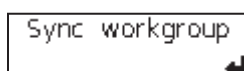
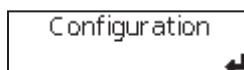

The controller is stand-alone.



- Select the value to change



The controller is selected as one of the secondary controllers of the workgroup.



- Validate



Tool ID
02

- Select the tool ID (position of the tool in the workgroup).

The monitoring screen will be as follows:

02



When changing from "Secondary" to "None", the network configuration previously set for the stand-alone controller will be restored.



- Refer to "Appendix - CVI3 connections" to get more information.

4.3 - Network



1 network		• Plug the Ethernet cable into any port.
2 networks		Ethernet network 1
		Ethernet network 2

- Enter the controller IP address, Subnet mask and Gateway parameters.

Configuration



Network



Gateway
127.000.000.001



- Select the value to change



- Change the value



- Validate



Network 1



IP address
192.168.005.199



SubNetMask
255.255.255.000

4.4 - Ping

This function is used to check the network connection with any device connected on the network.

- Select the IP address to ping.

There are 4 attempts.

Configuration



Network



PING
192.168.005.000



- Select the value to change



- Change the value



- Validate

PING
4/4 OK (2 ms)



4.5 - Fieldbus



- For more information about how to setup Fieldbus, refer to the CVI CONFIG user manual at <http://resource-center.desouttertools.com>.

4.6 - Customized protocol

- Plug the "ePOD customer" into the bottom panel of the controller.

Depending on the protocol used, the following icons are displayed in the monitoring screen.

	XML protocol
	PFCS protocol
	IPM protocol

	The controller is connected to the server.
	The controller is not connected to the server.



- "Customized protocol status" events are available.
- Refer to "Appendix - CVI3 I/O and events" to get more information.



- For further information, contact your Desoutter representative for support.

4.7 - Date & time

This function is used to synchronize the controller date and time to ensure that the tightening results are stored with the correct date and time.

Configuration



Service



Date
12/06/2014

- Change the current date if necessary.



Time
10:44:53

- Change the current time if necessary.



- Use CVI CONFIG software to select the date format and the synchronization source.

4.8 - Beep

If enabled, this function enables a "Beep" sound each time a button is pressed.

Configuration



Service



Beep

The beep is disabled.



Beep

The beep is enabled.

4.9 - Zoom in Control mode

The "Zoom" mode can be used to display:

- the torque value
- the angle value
- the report

When the "Zoom" mode is activated, the last result and the selected Pset are alternatively displayed full screen.

If any key is pressed, the zoom is removed and the default configuration is displayed.

Configuration



Service



Zoom
Disabled



Zoom
Torque



- Validate your selection.

Zoom
Angle



Zoom
Report

4.10 - Input/Output (reading only)

This part shows the status of the physical I/O of the controller.

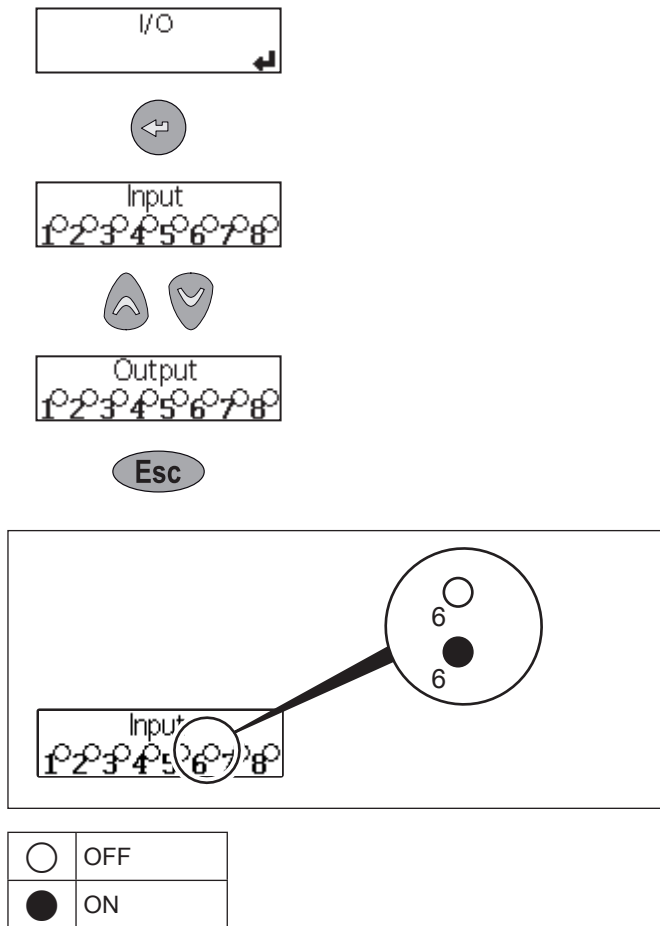

i • Refer to "Appendix - CVI3 I/O and events" to get more information.

i • Refer to "Appendix - CVI3 connections" to get more information.

4.11 - Access manager

It is recommended to protect the controller parameters against hazardous changes.

When the controller is delivered, the access manager is not activated and any modification can be done.



To activate the access manager on the controller, you need to have a USB stick with the right profile (configured with the Desoutter CVIKEY software).

- If not, contact your CVIKEY manager for support.

- Connect your USB stick to the front panel of the controller. The padlock will open to let you have access to the menu.

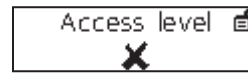

The padlock is not locked anymore.

By default, the protection of the data is not activated.



- Select to activate or not the protection of the data.



- Validate your selection.

- Remove the USB key from the controller.



The padlock is locked.

The controller protection is activated.



5 - MONITORING

5.1 - Pset/Assembly Process selection

5.1.1 - First selection



Upon delivery, the controller is waiting for the selection of a Pset or Assembly Process.

The tool is locked.



• Select the value to change. The question mark is blinking.



• Change the value



• Validate

5.1.2 - Control mode

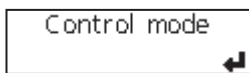

• Select the value to change



• Change the value



• Validate



5.2 - Last result



The report status is displayed: OK or NOK.



The torque and angle values are displayed.



The trend is displayed



The report details are available.



• Press this key to display the report details.

5.3 - Report details

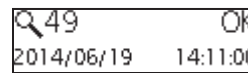

- Result number
- Report status
- Date
- Time



- Pset number



- Step number
- Stop source

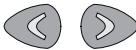

 to display the message when too long.



The last step is done.



The Pset has stopped before the last step.

OK The report is successful.

NOK The operation has failed.

5.4 - Monitoring symbols

Monitorings OK



Torque



Time



Overall time



Current





Torque rate











Angle



Overall angle

-  Second part angle 1
-  Second part angle 2
-  Rundown angle

5.5 - Trend symbols



-  The torque is below the minimum torque.
-  The torque is above the maximum torque.
-  The angle is below the minimum angle.
-  The angle is above the maximum angle.
-  The torque is in the tolerance of the target torque.
-  The angle is in the tolerance of the target angle.
-  The torque is above the assembly torque limit.
-  The angle is above the assembly angle limit.

6 - RESULTS

6.1 - Display of the last result



6.2 - Display of other results

-  
- Press one of these keys to select another result.
- Keep pressing the key to display the results by 10.

6.3 - Display of run reverse results

-  This icon indicates a run reverse operation.



7 - MAINTENANCE

7.1 - Controller

7.1.1 - USB key - Firmware upgrade

- Plug the USB key into the front panel port.



- Check you have 1 ".cvi3" image and 1 ".cvi3.md5" file only on your USB key.

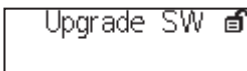

The controller beeps during 2 seconds and starts the process.



- Do not switch off the controller.
- Wait for the automatic reboot. The update lasts a few minutes.

When the upgrade is successful, the green LED is on.

7.1.2 - USB key - Save logs

- Plug any USB key into the front panel port.

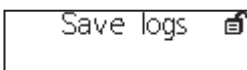

7.1.3 - USB key - Save config

- Plug any USB key into the front panel port.

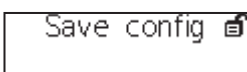

7.1.4 - USB key - Save results

- Plug any USB key into the front panel port.

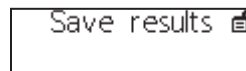

7.1.5 - USB key - Advanced diagnostic

- Plug any USB key into the front panel port.
- Select how often the logs are saved on the USB key.

Period	1/2/6/12/24 hour(s)
--------	---------------------



The period is blinking.



- Change the period.



- Do not unplug the USB key from the front panel.

7.1.6 - CVILOGIX

Pre-requisite:

- ePOD including the CVILOGIX function
- USB key including your own CVILOGIX program.
- Plug in the ePOD into the bottom panel.
- Plug in the USB key into the front panel.

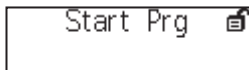

The CVILOGIX program is running.

In the control mode, the CVILOGIX logo is activated and displayed on the top left of the monitoring screen.



The program is running.



The program is stopped.

Other functions:

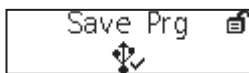
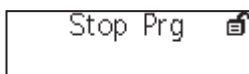

to save the program on any USB stick connected to the controller front panel.

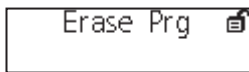

Mandatory

- Use the "Eject" command to unplug the ePOD from the controller.



- Contact your local Desoutter representative for more information.

7.1.7 - Memory

- Select which type of information to erase from the controller memory:
 - results
 - user information
 - Psets and Assembly Processes configurations

For example:

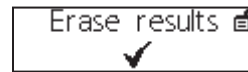
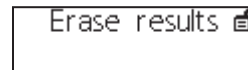

7.2 - ePOD

- Plug in the ePOD into the controller.



- For more information about installing the ePOD, refer to the installation manual" part no. 6159931050 at <http://resource-center.desouttertools.com>.

7.2.1 - Backup/Restore

- Select first the backup mode: manual or automatic.

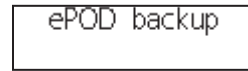

The ePOD is a snapshot of the controller.

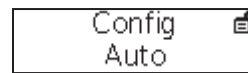

Each modification is saved in real-time in the ePOD. The ePOD acts as the controller mirror.

In both modes:



- Select "Backup" to start the process.

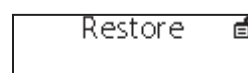

- Select "Restore" to transfer the data from the ePOD to the controller.



7.2.2 - Eject



Mandatory

- Use the "Eject" command to unplug the ePOD from the controller.

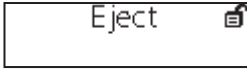

- Unplug the ePOD.

7.2.3 - Repair

- Use this function to start a recovery attempt of the data and results from the ePOD.



7.2.4 - Erase results

- Use this function to erase all results stored in the ePOD.

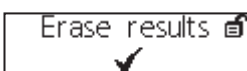
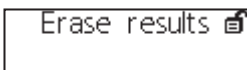
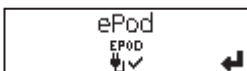

7.3 - User information

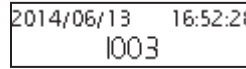
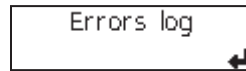

to display the description.

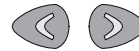
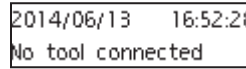

to display the next code.

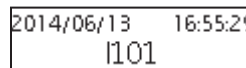

This icon indicates that the user information can be acknowledged.



- Press this key to clear the screen.



- Refer to "Appendix - User info codes" to get more information.

7.4 - Firmware version

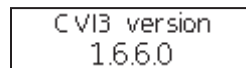
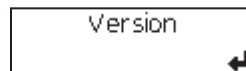

This information is useful to exchange information with Desoutter Servicing.



- Refer to chapter "7.1.1 - USB key - Firmware upgrade" to update the controller.

APPENDIX - I/O AND EVENTS

1 - LOGICAL OUTPUTS

Name	Description	Raising condition	Falling condition
General status			
Ready	The system is free of any internal issue that could prevent it from being fully operative. Communication between controller and tool is OK.	No error in controller nor in tool	- Quick stop activated - Error coming from the system
Identifier OK	Identifier received (e.g. barcode) matches masks (stays during 0.5 s at active level).	Identifier received and identified	0.5 s after rising
Identifier NOK	Identifier received (e.g. barcode) does not match masks (stays during 0.5 s at active level).	Identifier received but not identified	0.5 s after rising
User info present	User info (Info, Warning or Error) is present.	User info present on screen	No user info on screen
Keep alive ack	This output is the copy of the "Keep alive" input. It can be used by the PLC to check the controller is still running.	When "Keep alive" input raises.	When "Keep alive" input falls.
Fieldbus fault	No Fieldbus. The "Fieldbus fault" is on as long as the Fieldbus communication is not established. It switches off automatically when the communication works again.	Communication lost and/or keep alive missing.	Fieldbus communication established and keep alive present
Reporting Alarm	When working with ToolsNet or CVINet: FIFO Threshold Alarm reached. Results are stored in the controller memory and are erased when sent to ToolsNet or CVINet. This way the controller memory will never be full. A full controller memory induces result losses and traceability error. To detect communication issues with ToolsNet or CVINet, the software measures the fill in rate (%) of the memory. When the rate overpasses the target threshold, the Reporting alarm will switch on; maintenance operators are then able to solve the issue before losing results.	FIFO Threshold Alarm reached	FIFO under threshold alarm.
Open Protocol activated	Open Protocol is activated in configuration	Protocol is enabled	Protocol is disabled
Open Protocol connected	Open Protocol is connected to the Tightening Unit	At least 1 peer connected	No peer is connected
Time synchro done	Time synchronisation completed successfully using Fieldbus data (Q_SYN in VWXML)	-	-
Emergency stop	Emergency stop is activated	Emergency stop activated	Emergency stop deactivated
Tool status			
Tool ready	The tool is ready: - communication between controller and tool is ok - a valid Pset has to be selected - the tightening strategy must cope with the tool"	Tool connected AND valid Pset.	Tool disconnection, Pset selection.
Tool not locked forward	There is no tool lock in forward direction.	Tool unlocked in forward direction	New lock in forward direction
Tool not locked reverse	There is no tool lock in reverse direction.	Tool unlocked in reverse direction	New lock in reverse direction
Tool running	The tool is running (CW or CCW, tightening or loosening).	Tool starts to run.	Turns off when the tool stops.
Tool direction	Indicates if the tool is in tightening mode. Active: tightening mode Inactive: run reverse mode Note: independent if tool is running or not.	Entering tightening mode.	Entering run reverse mode.
Tool tightening	Tool is running in tightening mode. Pset threshold is not taken into account.	Tool start in tightening mode.	Tool stops.
Tool middle course trigger	Reflects the raw state of tool middle course start trigger, independently from Tightening Unit state.	Middle course of main trigger is reached	Main trigger is completely released.
Tool main start trigger	Reflects the raw state of tool main course start trigger, independently from the Tightening Unit state.	Trigger is pushed.	Trigger is released

Name	Description	Raising condition	Falling condition
Tool push start or front start trigger	Reflects the raw state of tool push start or front start trigger, independently from the Tightening Unit state.	Trigger is pushed.	Trigger is released
Manual reverse in progress	The operator has selected the reverse direction on the tool and is running the tool.	Manual runreverse selected and trigger pushed.	Stays on as long as the operator is running the tool
Fastener loosened	There is a fixed minimum torque value to declare that the fastener was "loosened".	Run reverse Result generation.	New start (tool trigger or external start)
Tube nut open	Indicates that the tube nut is open. The tool can be removed from the assembly.	-	Tool running
Tool maintenance alarm	Reflects the different tool maintenance alarm state with or condition.	Tool maintenance alarm 1 or 2 is active.	No tool maintenance alarm is active.
Invalid spindle settings	Tool characteristics does not match Pset parameters (e.g. negative jog times or contradictions, torque over the maximum tool torque range, speed over the maximum tool speed, maximum tool torque range, etc...)	Pset selection or tool connection.	Tool disconnection or new Pset selected.
Span failure	When starting a tightening, before running the tool, the controller checks the torque span. "Span failure" indicates that the span drifts by $\pm 3\%$ or more, causing a tool lockout. This fault can be due to the torque transducer or the tool electronics. The only solution is to replace the tool.	Span failure detection.	Disconnecting tool or new check without fault.
Offset failure	Indicates the offset (0 point) drifts by 50 % of full scale or more. This error exists when, at the beginning of the Pset, the torque transducer is seen to have 50 % or more of full-scale torque prior to even starting the motor. With an "Offset failure", the controller cannot adequately compensate for this transducer error and, therefore, will not allow a tightening operation to occur. The only solution is to replace the tool. Offset failures can come from a severely damaged torque transducer, a bad field cable or a bad controller.	Offset failure detection	Disconnecting tool or new check without fault.
Motor over temperature	Indicates that the temperature of the tool motor windings has exceeded the temperature threshold. An error message remains.	Temperature threshold: - 100°C for fixed tools - 60°C for portable tools	The signal turns off as soon as the temperature returns below the threshold (minus hysteresis = 10°C).
Angle measurement fault	Drive detected angle sensor fault. It can be an angle sensor fault, a tool electronic fault or a combination of both. The communication is tested permanently. As soon as the fault disappears, the signal turns off.	Angle fault detection.	Disconnecting tool
Angle measurement fault	Drive detected angle sensor fault. It can be an angle sensor fault, a tool electronic fault or a combination of both. The communication is tested permanently. As soon as the fault disappears, the signal turns off.	Angle fault detection.	Disconnecting tool
No tool connected	Indicates that the controller is not detecting the tool. Controllers are designed to work with a range of fastening tools. The tools have an Intelligent Tool Interface (ITI) board which is continuously sending status information to the controller. If the controller requests status information from the tool and gets no response, the controller software turns on the "No tool connected" output. This output resets immediately upon successful communication with a tool.	No tool connected or tool not recognized	Tool connected and recognized.
Redundancy error	Redundancy error in case of operational control transducer and faulty monitoring transducer.	Result generation	Use of "reset of redundancy error" input, change of tool free of this error

Name	Description	Raising condition	Falling condition
Pset status			
Pset selected bits (0..7)	Echoes the binary "Pset select bit 0 to 7" input if the corresponding Pset exists, echoes 0 if the Pset does not exist or there is no Pset selected.	New Pset selected	New Pset selected
Tightening running (old cycle declared)	This indicates that the fastening operation has actually started: the tool is running and the torque is over the Pset start torque threshold. The signal switches off as soon as the fastening operation is finished (all reports sent).	Torque reach the cycle start threshold.	The fastening operation is finished (all reports sent)
Tightening finished	Indicates that a Pset report is available.	Result generation.	New start (tool trigger or external start) or reset input
Tightening OK	Indicates that the fastening operation (for a specific Tightening Unit) ends correctly and that all controlled and monitored tightening parameters are within tolerances.	Result generation.	New start (tool trigger or external start) or reset input
Tightening NOK	Indicates that the fastening operation (for a specific Tightening Unit) has failed.	Result generation.	New start (tool trigger or external start) or reset input
Spindle OK	Indicates that the fastening operation (for a specific tool) ends correctly and that all controlled and monitored tightening parameters are within tolerances.	Result generation.	New start (tool trigger or external start) or reset input
Spindle NOK	Indicates that the fastening operation (for a specific tool has failed.	Result generation.	New start (tool trigger or external start) or reset input
Angle low	Indicates a low angle reject. The angle must meet or exceed this value for a correct Pset. When the angle stays below this value, it becomes a "Low angle reject" and this output is turned on. Stays on until a new fastening operation starts.	Result generation.	New start (tool trigger or external start) or reset input
Angle OK	Indicates a correct angle. The angle is inside the limits declared in the step.	Result generation.	New start (tool trigger or external start) or reset input
Angle high	Indicates a high angle reject. The angle must stay below this value to be a correct Pset. When the angle meets or exceeds this value, it becomes a "High angle reject". The tool will stop when this limit is reached and this output is turned on. Stays on until a new fastening operation starts.	Result generation.	New start (tool trigger or external start) or reset input
Torque low	Indicates the peak torque low reject. If the torque stays below the "Peak torque low limit" and results in a "Reject" Pset. This can happen when a Pset is prematurely finished, a thread strips out or when the Pset is automatically finished due to other error conditions, such as a High angle fault or when a Pset Time Monitor expires and causes the Pset to be terminated. Stays on until a new fastening operation starts.	Result generation.	New start (tool trigger or external start) or reset input
Torque OK	Indicates a correct torque. Torque is in inside the limits declared in the step.	Result generation.	New start (tool trigger or external start) or reset input
Torque high	Indicates the peak torque high reject. When the torque meets or exceeds this value, this output is turned on and the results is NOK. If a Peak Torque High error persists, it may be advisable to slow down the tool speed or replace the tool with one of lesser capacity. A second variable that can cause Peak Torque High errors is a badly chattering joint. Chatter is the squawking noise you hear on some fasteners at the end of the fastening operation. Chatter is induced by slip-stick and actually causes the fastener to momentarily stop rotating, then crack loose and re-start turning. This condition can cause a Peak Torque High condition. A potential solution for this is to view Psets, General Tab, and set the frequency response slide bar to Better Noise Immunity, Chattering Joint). This causes the software to average many torque readings together to minimize the possibility of using a single high frequency torque value that could trigger a peak torque high fault. Stays on as long as a new fastening operation starts.	Result generation.	New start (tool trigger or external start) or reset input

Name	Description	Raising condition	Falling condition
Yellow report on tightening controller	This output reflects the state of the controller yellow light.	Controller yellow light is on	New fastening operation starts
Green report on tightening controller	This output reflects the state of the controller green light.	Controller green light is on	New fastening operation starts
Red report on tightening controller	This output reflects the state of the controller red light.	Controller red light is on	New fastening operation starts
Lock on reject	Indicates that a tool is locked out because of an incorrect tightening operation. The controller will not continue to run the tool depending on "lock on reject option": - until the "Error Acknowledge" input is activated. - until a run reverse operation - until a loosening operation"	Tightening finished with bad result and option "Lock on reject" activated.	Input "Error acknowledge" activated or runreverse operation or loosening operation
Remove fastener	Indicates that the fastening operation resulted in a torque that exceeded the "Remove Fastener" setpoint. When correctly set, this means that the torque for any reason becomes very high. There is a risk that the fastening operation is not reliable: disassemble the joint and check parts.	Result generation.	New start (tool trigger or external start) or reset input
Tightening finished without timeout	Indicates that a Pset report is available and the source stop is not overall timeout.	Result generation.	New start (tool trigger or external start) or reset input
Overall time reached	Max overall time has been reached during tightening	Result generation.	New start (tool trigger or external start) or reset input
Synchro out	Synchro output: set to 1 when running step starts, reset to 0 when a synchro step is reached.	Start of running step.	Synchro step reached
Invalid parameter set selected	Indicates the Pset is disabled (has not been set). For example, if 3 Psets are used, Psets 1, 2 and 3 are enabled. If, however, any Pset other than 1, 2 or 3 is selected, the Pset is invalid and this output is turned on. It is possible for an Assembly Process to select invalid Psets.	Pset unselection	Pset selection
Assembly Process status			
Assembly Process selected bits (0..7)	Indicates the Assembly Operation per Tightening Unit currently selected (Bit 0..7)	New AP selected. AP aborted	New AP selected. AP aborted
Assembly Process running	Indicates the assembly operation is being processed. The signal is on as long as the assembly operation is running. The signal falls down when the assembly operation is finished.	Assembly Process start.	Assembly Process finished or aborted.
Assembly Process finished	Indicates when an assembly operation is completed.	Assembly Process finished.	A new Assembly Process start or reset input
Assembly Process OK	Indicates when an assembly operation is completed with no rejects. The signal stays on as long as a new Assembly Process starts.	Assembly Process finished and OK.	A new Assembly Process start or reset input
Assembly Process NOK	Indicates when an Assembly Process reject occurs. Stays on as long as a new Assembly Process starts.	Assembly Process finished and NOK or aborted.	A new Assembly Process start or reset input
Assembly Process aborted	When an Assembly Process has been aborted, "Assembly Process aborted" is activated. Stays on as long as a new Assembly Process starts.	Assembly Process aborted.	A new Assembly Process start or reset input
Current batch count bit (0..6)	Bit indicator of current batch count	Batch count increment	when batch is finished, new start (tool trigger or external start) or reset input or new AP selection
Remaining batch count bit (0-6)	Bit indicator of the number of remaining bolts in the batch	Batch count increment	When batch is finished, new start (tool trigger or external start) or reset input or new AP selection

Name	Description	Raising condition	Falling condition
Batch running	A batch process is underway. The output is set to 1 before the first tightening operation.	A batch operation is enabled	Batch is finished or reset input
Batch finished	Indicates when the batch count equals the batch size and the batch is declared completed. It is used together with "Batch OK" to indicate the status of a batch.	Batch is finished.	New start (tool trigger or external start) or reset input
Batch OK	Indicates the status of the batch together with the "Batch finished" output (managed by Assembly Process).	Batch is finished and OK.	New start (tool trigger or external start) or reset input
Batch NOK	Such as when the batch gets aborted...or in the case rejects are included as part of the batch count (managed by Assembly Process).	Batch is finished and NOK. A new AP has been selected.	New start (tool trigger or external start) or reset input
External outputs AP			
External Out AP bit	Outputs that can be set or reset within an Assembly Process	Depending of AP behavior	Depending of AP behavior
External outputs PLC			
External Out PLC bit (0..9)	Indicates this output is controlled by a PLC via Fieldbus (like a remote I/O). On PLC side, it is an output.	Depending on PLC behavior	Depending on PLC behavior
External outputs OP			
External Out OP bit (0..9)	Outputs dedicated to Open Protocol.	Depending on OP behavior	Depending on OP behavior
Socket tray			
Socket selectable (0..4)	24 V socket trays (BSD). Informs which socket can be taken by the operator.	A new socket has to be taken by the user.	No socket to be taken by the user.
Customized protocol Status			
Customer protocol activated	A customer protocol has been activated in configuration	Protocol is enabled	Protocol is disabled
Customer protocol connected	The activated customer protocol is connected	Protocol is connected	Protocol is disconnected
Customer protocol reporting alarm	The activated customer protocol has declared an alarm about result reporting of this Tightening Unit.	Alarm is raised	Alarm is cleared
Q_SAS	ACK start tightening job	-	-
RDY	Controller ready	-	-
Q_LSN	Reverse disabled	-	-
WGZ	Tool disabled	-	-
Q_EDZ	Result and reports reset	-	-
Q_XMS	XML data transfer completed	-	-
EIO	Result OK	-	-
ENO	Result NOK	-	-
FSCIO	Group status OK	-	-
FSCNIO	Group status NOK	-	-
CVILOGIX			
External Out CVILogix bit (0..100)	Indicates that this output can be used by an internal CVILOGIX application.	-	-
Miscellaneous			
ON	On state, used to set level "1" to physical outputs.	At controller startup.	Never falls
OFF	Off state, used to set level "0" to physical outputs.	At controller startup.	Never falls

2 - LOGICAL INPUTS

Name	Description	Status
General commands		
Start stop Tightening on state	Initiates a fastening cycle if: <ul style="list-style-type: none"> - the "Spindle validation forward" is active and required by the Tightening Unit, - a Pset is selected. A rising edge must be detected to initiate a tightening, that is the change in the state of the tool from off to on as the trigger is released, then pressed again must be detected. For the tightening to proceed, this input must remain active. If this input becomes inactive at any time during the tightening, the tightening will be aborted and the tool will stop running. At the end of tightening, a tightening can began only if signal falls and then rise. After power-up, even if this signal is active, an edge is necessary to start tightening."	State
Toggle start stop tightening on edge	This input is enabled for fixed tools only (tools without trigger). Initiates or ends a fastening cycle. A cycle can be initiated only if: <ul style="list-style-type: none"> - the "Spindle validation forward" is active and required by the Tightening Unit - the Pset is selected If no tightening is currently executed, a rising edge will initiate a tightening. A falling edge has no effect on the tightening to proceed. If a tightening is in execution, a rising edge will stop it.	Rising edge
Reverse direction	When activated, the tool green & red lights are flashing to indicate that the Tightening Unit reverse direction is selected. This signal status is not controlled during a tightening but only when tool is not running.	State
Error acknowledge	Enables the "Reject lockout" function. When locked out, the tool cannot run until this input is reset.	Rising edge
Reset	When input reset raises (and there is no cycle running): <ul style="list-style-type: none"> - defaults are acknowledged - batch counter of current Assembly Process is reset - reports lights on controller and tool are set off - result on display is erased but the last 5 result values on Vision display stay readable - in Pset mode, Pset selected remains unchanged. In AP mode, AP is aborted. - ready output stay on - echo identifier is reset When input reset raises (and there is cycle running): <ul style="list-style-type: none"> - tightening is immediately stopped - defaults are acknowledged - batch counter of current Assembly Process is reset - at tightening end, there is no report generated. - at tightening end, it is impossible to start a new tight, reset input must be released first. - in Pset mode, Pset selected remains unchanged. In AP mode, AP is aborted. - ready output stay on - echo identifier is reset 	State
Reset only status	When the input "Reset" raises during the Pset running: <ul style="list-style-type: none"> - tightening is immediately stopped Resets only: <ul style="list-style-type: none"> - Tightening OK/NOK/finished - Tool OK/NOK - Batch OK/NOK/Finished The Assembly Process is not aborted. Result values (angle, torque) are still present in Fieldbus. LEDs on tool and controller are not affected.	State
Ack error message	Acknowledge error message displayed on HMI.	Rising edge
Force Pset mode	Forces the Tightening Unit to switch in Pset mode in order to temporary run Psets (nothing saved). When AP mode + input state high, then switch to Pset mode. When Temporary Pset mode + input state low, then switch to AP mode. Switching on the controller power with the input set will switch to Pset mode. Other cases do nothing.	State
Ack result	Acknowledges the current result. The tool is then unlocked and can tight again. Formerly dedicated to Fieldbus only, this behaviour is now also available for IOs and Open Protocol.	Rising edge
Keep alive	Input used to check that the controller is still alive. State of this input is copied to "Keep alive ack" output. This input is also used by a PLC to inform the controller that Fieldbus communication is working.	State
Time Synchro Trigger	Execute date & time synchronisation from Fieldbus (SYN in VWXML protocol)	Rising edge

Name	Description	Status
Enable access manager	Enable/disable access manager	State
Lock display	Lock/unlock the controller display.	State
Restart Controller	Reboots the controller. Everything must be done by the software before using this input	Rising edge
Tools commands		
Tool validation forward	Enables the tool to run the selected Pset. Note: the forward and reverse validation can be done by setting both validations on the same input. When the validation signal falls down, the tool stops.	State
Tool validation reverse	Enables the tool run reverse. Note: the forward and reverse validation can be done by setting both validations on the same input. When the validation signal falls down, the tool stops.	State
Reset tool locks	Reset tool locks, only the none safety tool locks will be affected	Rising edge
Tool stop	Stops the tool.	Rising edge
Tool blue light ctrl by IO	1 = Tool blue light is controlled by IO 0 = Tool blue light is managed by the controller	State
Tool blue light	If "Tool blue light ctrl by IO" is set to 1 (see upward) then: 1 = tool blue light is set to on 0 = tool blue light is set to off	State
Tool green light ctrl by IO	1 = Tool green light is controlled by IO 0 = Tool green light is managed by the controller	State
Tool green light	If "Tool green light ctrl by IO" is set to 1 (see upward) then: 1 = tool green light is set to on 0 = tool green light is set to off	State
Tool red light ctrl by IO	1 = Tool red light is controlled by IO 0 = Tool red light is managed by the controller	State
Tool red light	If "Tool red light ctrl by IO" is set to 1 (see upward) then: 1 = tool red light is set to on 0 = tool red light is set to off	State
Tool yellow light ctrl by IO	1 = Tool yellow light is controlled by IO 0 = Tool yellow light is managed by the controller	State
Tool yellow light	If "Tool yellow light ctrl by IO" is set to 1 (see upward) then: 1 = tool yellow light is set to on 0 = tool yellow light is set to off	State
Tool white light ctrl by IO	1 = Tool white light is controlled by IO 0 = Tool white light is managed by the controller	State
Tool white light	If "Tool white light ctrl by IO" is set to 1 (see upward) then: 1 = tool white light is set to on 0 = tool white light is set to off	State
Reset of redundancy error	Resets redundancy error only.	State
Pset commands		
Pset select bit (0..7)	Used to select Psets. These inputs must be in the desired state BEFORE the activation of the cycle start input. If the selected Pset is zero, there is no Pset selected.	State
Select previous Pset	Select lower number Pset.	Rising edge
Select next Pset	Select higher number Pset.	Rising edge
External stop abort Pset	This input is used with proximity detectors to end immediately Pset running. The user can choose which state or transition will stop the Pset: No, Rising, Falling, Change, High, Low. When a Pset is aborted with this input, the Pset result is NOK.	Rising edge or state
External stop to next step	This input is used with proximity detectors to end the running step. The user can choose which state or transition will stop the Pset : No, Rising, Falling, Change, High, Low. The user can also choose the step result when the stop request occurs: OK, NOK, Monitoring (Monitoring means that the result is computed depending on monitoring requested).	Rising edge or state
Synchro in	Step synchronisation input. The step starts when a transition to 0 is detected.	State

Name	Description	Status
Assembly Process commands		
Assembly Process selection bit (0-7)	Used to select an Assembly Process. These inputs must be in the desired state BEFORE the activation of the assembly process start input.	Rising edge
Abort assembly process (tightening unit)	The "Abort assembly process" input stops the Assembly Process being processed. The Assembly Process is finished. The Assembly Process result is memorized as "aborted" and "AP aborted" and "AP NOK" events are set.	Rising edge
Batch-1	The "Batch-1" input allows the operator to select the previous operation of a batch whatever the result of the next operation. The batch counter is decremented. The action is recorded OK or NOK according to the result and "Batch-1 event" is set.	Rising edge
Batch+1	In case you cannot complete the current operation of a batch, jump to the next one by using the external input "Batch+1". The action is declared as NOK and "Batch+1" event is set.	Rising edge
Restart batch	Restarts the current batch of the current Assembly Process step. The "Restart batch" event is set.	Rising edge
Reset number of retries	Reset the number of retries counter. If the max counter has been reached, the tool is unlocked.	Rising edge
External inputs AP		
External in AP bit (0..9)	Inputs used in Assembly Process in start conditions or in assembly actions sense input	Rising edge
External inputs PLC		
External In PLC bit (0..9)	Indicates this input can be used by an PLC via Fieldbus (like a remote I/O). For PLC side, it is an input.	State
External inputs OP		
External In Open Protocol 1-8	Inputs used in Open Protocol. They can be monitored from the Open Protocol client by subscription. These Dign are named "External monitored 1..8" in Open Protocol specification.	State
Socket tray		
Socket lifted bit (0..4)	Used with CVI II controllers only: 24V socket trays (BSD). Informs which socket has been lifted.	State
Customized protocol commands		
PFCS END OF CYCLE	Input used in PFCS Chrysler to flush the result FIFO when the operator has completed the work	Rising edge
SAS	Starts tightening job	State
RST	Resets any running tightening job	State
LSN	Disables reverse	State
TOL	Tool validation	State
STR	Tool start	State
EDZ	Resets results	State
XMS	Synchronous XML	State
XMA	XML activated	State
CVILOGIX		
External In CVIlogix bit (0..100)	Indicates that this input can be used by an internal CVILOGIX application	State

APPENDIX - USER INFO CODES

Code no.	Description	Resolution procedure
2	Tool connected	1- The tool is connected and correctly recognized by the controller.
3	No tool connected	1- Tool has been disconnected. 2- If the tool is not physically disconnected, check the tool cable.
4	Span failure	1- Span value from torque sensor is outside bounds. 2 -Try once again to start the tool with no mechanical constraints. If the problem occurs again, contact your Desoutter representative for support
5	Offset failure	1- Offset value from torque sensor is outside bounds. 2- Try once again to start the tool with no mechanical constraints. If the problem occurs again, contact your Desoutter representative for support.
6	Tool motor rotor locked	1-Unable to start tool motor (rotor is locked), change your tool 2-Contact your Desoutter representative for support
7	Tool motor too hot	1- Tool is locked because its maximum motor temperature has been reached. 2- Tool will remain locked until the motor temperature comes back to its normal value.
8	Tool angle fault	1- Problem detected with the tool angle sensor 2- The tool needs maintenance. 3- Contact your Desoutter representative for support
9	Tool invalid parameters	1- Please check the tool compatibility. 2- The tool memory cannot be read or is invalid. 3- The tool needs maintenance. If the problem occurs again, contact your Desoutter representative for support.
10	Tool calibration alarm date expired	1- The tool calibration date has expired. 2- A tool calibration procedure needs to be done to ensure the measurement accuracy.
12	Tool EEPROM could not be read	1- The tool memory cannot be read or is invalid. 2- The tool needs maintenance. If the problem occurs again, contact your Desoutter representative for support.
13	Tool motor bad ground connection	1- Phase-phase or phase to ground shortcircuit. 2- Disconnect the tool. Contact your Desoutter representative for support.
14	Tool torque power default	1- The torque sensor is not correctly supplied 2- The tool needs maintenance. If the problem occurs again, contact your Desoutter representative for support.
15	Tool locked on reject	1- The tool is locked forward after a NOK. 2- Unlock the tool in function of the "lock on reject option" selection i.e. by reversing, loosening or input.
16	Tool locked by Open Protocol	1- Tool has been locked by Open Protocol 2- Unlock the tool by sending an Enable tool message via Open Protocol
17	Loosening prohibited	1- Loosening is prohibited 2- The loosening is disabled in the Assembly action 3- The batch count type OK + NOK is used
18	Tool torque out of range	1- The target torque value is above the tool max. torque. 2- Check Pset settings against tool characteristics.
19	Tool communication error	1- Tool communication error. 2- Check tool and cable connections. If the problem occurs again, contact your Desoutter representative for support.
20	Tool LED over current	1-Tool LED are not correctly supplied 2- Disconnect and reconnect the tool. If the problem occurs again, contact your Desoutter representative for support.
21	Number of retries reached	1- The number of retries max has been reached. 2- The tool is locked. 3- The running Assembly Process has to be aborted.
22	Tool locked, lift correct socket	1- The tool is locked. Put all sockets back and lift the correct socket(s) combination.
23	Unsupported tool	1- The tool connected to the controller is not supported. 2- Contact your Desoutter representative for more information.
24	Tool loosening prohibited by VW XML	1- Loosening is disabled by VWXML protocol
25	Tool tightening prohibited by VW XML	1- Tightening is prohibited by VWXML protocol
26	Tool maintenance alarm 1	1- Tool maintenance tightening counter has been reached
27	Tool maintenance alarm number 2	1- Tool maintenance tightening counter has been reached
28	CVI3 and ExBC SW versions incompatible	1 - Battery tool version and controller version are not compatible.
29	The battery is empty	1- The battery is discharged. The tool cannot tighten. 2- Recharge the battery.
30	The battery is low	1- The battery is low. 2- Recharge the battery.
31	Battery error	1- Abnormal battery voltage, the tool cannot tighten. 2- Recharge the battery. If the problem occurs again, replace the battery.

Code no.	Description	Resolution procedure
32	Tool display error	1- Board display malfunction. 2- Contact your Desoutter representative for support.
33	Tool time error	1- The tool time is not set correctly. The tightening results will not be time stamped. 2- Connect the tool to the controller to set date and time.
34	Tool memory error	1- The tool memory does not work properly. 2- Contact your Desoutter representative for support.
35	Tool memory locked	1- The tool memory is locked to protect old data from rewriting. 2- Connect the tool to E-dock to retrieve old data.
36	Tool memory full	1- The tool memory is full. 2- Connect the tool to the controller to empty the memory.
37	Tool trigger error	1- The tool trigger does not work properly. 2- Check and clean the trigger. If the problem occurs again, contact your Desoutter representative for support.
38	Tool logs are available	1- Unexpected tool software exception 2- Log file has been generated by the tool 3-Contact your Desoutter representative for support
39	Tightening Unit config error	1- Tightening Unit settings are invalid
40	Tool over speed	1- Motor speed exceeds 130% of its maximum value. 2- Check tool parameters. 3- Wrong motortune parameters. Contact your Desoutter representative for support.
41	The tool is unauthorized	1- The tool connected to the controller is not authorized. 2 Maximum number of battery tool reached or tightening unit associated doesn't exist anymore 3- Check the ePOD connection and capacity.
42	Tool locked by GeoPositioning	1- Tool has been locked by GeoPositioning 2- Unlock the tool by moving the tool in its defined area
45	Anormal battery high voltage, check your battery	1- Anormal battery high voltage, check your battery. 2- This error can due to charger malfunction or end of life battery.
46	Anormal battery current consumption, check your PSet settings	1- Anormal battery current consumption, check your PSet settings. 2- This error can due to speed settings.
47	Battery is too low, check your battery	1- Battery is too low, check your battery. 2- If the problem occurred again, change the battery with a new one.
48	Battery type not allowed	1- Battery type not allowed. 2- Change your battery type or your configuration.
49	Access denied on controller	Access denied on controller
50	Incompatible network parameters	Incompatible network parameters
51	Epod connected	Epod connected
52	Incorrect network parameters	Incorrect network parameters
53	No TU available	No TU available
54	Pairing success	Pairing success
55	EDock already present on controller	EDock already present on controller
56	Epod disconnected	Epod disconnected
58	Tool locked by GeoTracking	1- Tool has been locked by GeoTracking 2- Unlock the tool by moving the tool in its defined are
59	New tool detected	No procedure
60	Tool synchro ongoing	No procedure
100	Tool cable id invalid parameters	1- Invalid tool cable parameter, check that the tool cable is Desoutter certified 2- Contact your Desoutter representative for support
101	Tool cable id not detected	1- Tool cable communication error, check that the tool cable is Desoutter certified 2- Contact your Desoutter representative for support
102	Tool cable id not certified	1- Tool cable authentication error, check that the tool cable is Desoutter certified 2- Contact your Desoutter representative for support
199	Serial console activated	1- The serial console is activated. 2- Warning, this console is dedicated only to debug purposes and should not be used in production
200	Quick stop activated	1- The quick stop has been activated 2- Check the Phoenix connector
201	Replace backup battery	1- The real time clock backup battery needs to be replaced.
202	Fieldbus connection lost	1- Fieldbus connection with PLC is lost. - no heartbeat is received from PLC - the cable is broken or disconnected - the PLC is off line or not powered 2- Check the Fieldbus configuration.
204	Tool not validated by IO	1- Tool locked by I/O. 2- Check the I/O settings: the "Tool validation" must be active to unlock the tool.
205	Torque settings and tool mismatch	1-Invalid Torque setting, torque is greater than tool characteristics 2-Check Pset settings with the current tool characteristics

Code no.	Description	Resolution procedure
206	Speed settings and tool mismatch	1-Invalid speed setting, speed is greater than tool characteristics 2-Check Pset settings with the tool max. speed.
207	Assembly process done	1- Assembly Process is done, the tool is locked 2- Select new Assembly Process to unlock the tool
208	Invalid run reverse parameters	1-Invalid Run reverse setting, torque or speed are greater than tool characteristics or reverse strategy is not supported 2-Check Pset settings with the current tool characteristics
209	Pset invalid parameters	1 - Software internal error. 2 - Pset is corrupted. Try to transfer it again to the controller. 3 - If the error persists contact your Desoutter representative for support.
210	Invalid Pset selected	1- The Pset currently selected does not match the selectable one in the Assembly Process.
211	Invalid trigger configuration	1- The tool currently connected to the CVI3 is not equipped with the trigger required by the tool trigger configuration 2- Adjust your tool trigger configuration to the tool connected or change the tool according to the expected trigger configuration
212	Result could not be persisted	1- It was not possible to persist the tightening result in the controller 2- Contact your Desoutter representative for support
213	Drive connection lost	1- Connection with the drive has been lost. 2- Reboot the controller. 3- If the issue remains, contact your Desoutter representative.
214	RS232 power short circuit	1- Serial peripheral default. 2- Disconnect and reconnect. 3- Check the serial peripheral.
215	Drive current calibration failed	1- Current calibration failed. 2- Try once again. 3- If the problem occurs again, contact your Desoutter representative for support.
216	Drive current too high	1-Max current exceeded. 2-Contact your Desoutter representative for support
217	Drive disabled	1-Drive disabled by external source. 2-Contact your Desoutter representative for support
218	Drive gate voltage too low	1- Drive hardware failure. 2- Safety issue: contact your Desoutter representative for support
219	Hardware channel failure	1- Drive hardware failure. 2- Safety issue. Contact your Desoutter representative for support.
220	Hardware trip	1- Drive hardware failure. 2- Safety issue. Contact your Desoutter representative for support.
221	Drive heart bit error	1- Drive hardware failure. 2- Safety issue. Contact your Desoutter representative for support.
222	Drive heatsink temperature high	1- Heatsink too warm. 2- Let the controller cool down.
223	Drive init error	1- Software failure. 2- Restart the controller. 3- If the problem occurs again, contact your Desoutter representative for support.
224	Drive junction temperature high	1- Power electronics too warm. 2- Let the controller cool down.
225	Drive missing angle	1- Tool communication error. 2- Check tool and cable connections. If the problem occurs again, contact your Desoutter representative for support.
226	Drive missing torque	1- Tool communication error. Check tool and cable connections. 2- Try once again, if the problem occurs again, contact your Desoutter representative for support.
227	Drive motor stalled	1- Motor stalled (could be missing phase, wrong motortune or power electronics failure) 2- Try once again, if the problem occurs again, contact your Desoutter representative for support.
228	Drive Software Error	1- Software failure 2- Restart the controller. 3- If the problem occurs again, contact your Desoutter representative for support
229	Drive PWM watchdog error	1- Software failure. 2- Restart the controller. 3- If the problem occurs again, contact your Desoutter representative for support.
230	Drive DC bus voltage high	1- Max current exceeded. DC-bus voltage high 2- Contact your Desoutter representative for support
231	Drive DC bus voltage too low	1- Power failure. DC-bus voltage low 2- Contact your Desoutter representative for support.
232	Fieldbus module not recognized not a Desoutter one	1- The Fieldbus module plugged in the controller cannot be run. It is not an authorized Desoutter module. 2- Contact your Desoutter representative for more information.
233	CVINet FIFO full	1- The CVINet result FIFO is full, the CVINet connection has been lost 2- Check the CVI3 Ethernet cable 3- Check CVI3 Ethernet configuration 4- Check if CVINet is running correctly

Code no.	Description	Resolution procedure
234	Fieldbus module mismatch	1-The Fieldbus module declared in configuration is not the same that the one present in controller (e.g. Profibus declared but a Profinet module in CVI3).
235	Warning max speed setting	1- Invalid speed setting: speed is greater than tool characteristics 2- By default, speed setting has been replaced with tool max speed.
236	ToolsNet FIFO full	1- The ToolsNet result FIFO is full, the CVINet connection has been lost 2- Check the CVI3 Ethernet cable 3- Check CVI3 Ethernet configuration 4- Check if ToolsNet is running correctly
237	Fieldbus invalid process data	1- The Fieldbus mapping has too many items.
238	Fieldbus invalid device address	1- The device address affected to Fieldbus is invalid.
239	Fieldbus invalid communication settings	1- Fieldbus communication settings are invalid
240	VW XML protocol not authorized	1- The selected XML protocol is not authorized (check the ePOD characteristics)
241	CVINET FIFO alarm	1- The CVINet result FIFO has reached alarm threshold, the CVINet connection has been lost 2- Check the CVI3 Ethernet cable 3- Check CVI3 Ethernet configuration 4- Check if CVINet is running correctly
242	ToolsNet FIFO alarm	1- The ToolsNet result FIFO has reached alarm threshold, the CVINet connection has been lost 2- Check the CVI3 Ethernet cable 3- Check CVI3 Ethernet configuration 4- Check if ToolsNet is running correctly
243	PFCS not authorized	1- The selected PFCS protocol is not authorized (check the ePOD characteristics)
244	Accessory disconnected	1- The accessory at the given address has been disconnected from the eBUS of the CVI3. 2- Check the accessory cable.
245	Wait for report acknowledgement	Acknowledge report with its corresponding input
246	Problem in synchro I/O cable or configuration	1- Error detected on synchronisation input 2- Check the configuration of I/O 3- Check the synchronisation cable
247	Conflict of versions for XML protocol	1- Conflict detected in Audi / VW XML protocol version. 2- Check the coherence of the version between the controller and master PC/PLC
248	SAS order fail	1- Fieldbus SAS order has failed. 2- Check the value of RRG1, SIO, etc.
249	XML PRG value set by PLC is 0	1- The PRG value 0 has been set by Fieldbus.
250	Pset corrupted	1- Pset is not defined correctly 2- Check the Pset
251	No Pset selected	1- No Pset is selected 2- Select a Pset before start order
252	No tool involved	1- No tool is involved for the requested tightening 2- Check tool validation
253	Incorrect tool Id defined in Pset	1- Pset is not defined correctly. 2- One tool declared in the Pset is not part of the tightening unit 3- Check the Pset.
254	Drive communication error	1- Error detected in drive communication 2- Restart the controller 3- If the problem occurs again, contact your Desoutter representative for support
255	Drive choke too hot	1- Power electronics too warm. 2- Let the controller cool down.
256	Tool motor too hot	1- Tool is locked because its maximum motor temperature has been reached. 2- Tool will remain locked until the motor temperature comes back to its normal value.
257	Impossible to start remotely	1- Verify the tool trigger is correctly pushed
258	Calibration need Pset mode for this TU	1- For tool calibration, the Tightening Unit has to be in Pset mode 2- Change the Tightening Unit mode into Pset mode.
259	Reset input is active	1- "Reset" input is active 2- The Tightening Unit will unlock when input switches to inactive state.
260	IPM protocol not authorized	1- The selected IPM protocol is not authorized (check the ePOD connection)
261	Locked by IPM	1- IPM protocol has locked the controller 2- Check the connection with the IPM gateway 3- Check CVI3 IPM configuration
262	Open Protocol connection lost	1- Open protocol connection has been lost
263	Socket tray conflict	For this Tightening Unit, do not associate more than one socket combination to a Pset
264	Too many steps in PSet	Check that an Epod3 is connected to the controller to enable more steps per pset
265	Socket(s) usable with more than one TU	Reconfigure sockets combination to resolve conflicts
266	Message:	Incoming message received with dynamic text
267	Result transfer error	Result transfer error
268	CVI3 and CVI NET SW versions incompatible	CVI Net and CVI3 are incompatible. Please update CVI Net software
269	Pset modified	No procedure

Code no.	Description	Resolution procedure
300	Save log started	1- Saving the CVI3 logs to USB key has started
301	Save log done	1- Saving the CVI3 logs to USB key has ended
310	Identifier accepted	1- An identifier has been received and accepted. 2- The identifier is matching an Assembly process start condition
311	Identifier rejected	1- An identifier has been received 2- The identifier does not match any Assembly process start condition
312	Access right expired	1- The access rights on the USB key cannot be read 2- Unplug the key and insert it again 3- If the issue is persistent, the access right file is probably corrupt 4- Contact your CVI Key administrator.
313	Access right unreadable	1- The access rights on the USB key could not be read 2- Try unplug the key and insert it again 3- If the issue is persistent, the access right file is probably corrupt contact your CVI Key administrator
314	CVIKey plugged	1- an access key has been plugged
315	CVIKey unplugged	1- an access key has been unplugged
316	Barcode lost	no procedure
400	Default network configuration set	1- Network configuration has been set to default.
401	Network configuration failed	1- Network configuration failed. 2- Check your settings. 3- If the problem occurs again, contact your Desoutter representative for support.
500	CVILOGIX user info	Message generated by CVILOGIX program
501	CVILOGIX user info	Message generated by CVILOGIX program
502	CVILOGIX user info	Message generated by CVILOGIX program
888	Controller software updated	no procedure
889	Device Software Updated	Device Software Updated
890	Device Software Error	Device Software Error
891	Controller started	No procedure
899	Software downgrade not allowed	1- The SW downgrade is not allowed for this version 2- Check the CVI3 image version on your USB key 3- If the update is still failing, contact your Desoutter representative
900	CVI3 Software update failed	1- The SW upgrade failed 2- Do not remove the USB key and try to restart the CVI3 3- If the upgrade is still failing, contact your Desoutter representative
901	CVI3 Software image not found	1- The SW upgrade failed, no CVI3 image (*.cvi3) was found at the USB key root directory 2- Check your USB key, it must have only one CVI3 image
902	CVI3 Software image invalid	1- The SW upgrade failed, the CVI3 image copied on your USB key is corrupted 2- Remove and copy again your CVI3 image 3- Try another USB key 4- Contact your Desoutter representative for more information
903	CVI3 Software updater missing	1- The SW updater is not available or broken 2- Contact your Desoutter representative for more information
904	CVI3 save parameter utility not found	1- The save parameters utility is not available 2- Contact your Dessouter representative for upgrade
905	CVI3 save parameter to key failed. Key is full	1- Your USB key is full, all data were not saved 2- Delete your old backup files and try again
906	CVI3 save parameter failed	1- An error occurred during backup, data were not saved. 2- Check the available space on your key, delete files and try again. 3- If the problem persists, contact the Desoutter support team.
907	Wrong USB port	1- Your USB device is plugged into the wrong port 2- If your device is a USB key, plug it into the USB front port 3- If your device is a USB barcode reader or keyboard, plug it into the bottom USB ports
908	Too many USB HID devices connected	1- Too many USB devices (barcode reader or keyboard) are plugged to the controller 2- Remove all devices and plug them again to the bottom USB ports only.
909	USB HID device error	1- Your USB device is not supported by the CVI3 controller 2- Only USB barcode reader and USB keyboard are supported, if you use one of them, contact your Dessouter representative for upgrade
910	CVILOGIX save error	1- Plug a USB key to the front panel. 2- Check available space on your USB key, delete some old backup and try again.
911	CVILOGIX load error	1- Plug a USB key to the front panel. 2- The .zip file was not found, check that it is in the correct directory.
912	ePOD backup failed	1- Check the ePOD connection. 2- Contact your Desoutter representative for support.
913	ePOD restore failed	1- Check the ePOD connection. 2- Contact your Desoutter representative for support.
914	Maintenance ongoing	Maintenance ongoing: Refer to user manual
915	Inconsistent version	1- The SW version of all CVI3 controllers must be identical 2- Update firmware

Code no.	Description	Resolution procedure
916	Workgroup not authorized	1- You need to connect an epod3 on the Workgroup Primary controller
917	Invalid accessory configuration	1-The accessory configuration is not correct 2-Check type of elements and events associated
918	Emergency stop activated	1- The emergency stop has been activated 2- Check the M8 connector
919	additional transducer configuration error	1- The additional transducer's maximum torque is lesser than the embedded transducer's maximum torque 2- The Pset uses an additional transducer though non is installed on tool
920	Controller reset to factory settings	ePod automatic backup must be configure again if needed
921	Pset execution is not authorized	1-Check used features allowance 2-Contact your Desoutter representative for support
922	Additional transducer span failure	1- Span value from additional torque sensor is outside bounds. 2 -Try once again to start the tool with no mechanical constraints. If the problem occurs again, contact your Desoutter representative for support
923	Additional transducer offset failure	1- Offset value from additional torque sensor is outside bounds. 2- Try once again to start the tool with no mechanical constraints. If the problem occurs again, contact your Desoutter representative for support.
924	Tool calibration required	1-Perform a calibration of the tool on CVI3

APPENDIX - CONNECTIONS

1 - TOOL CONNECTOR

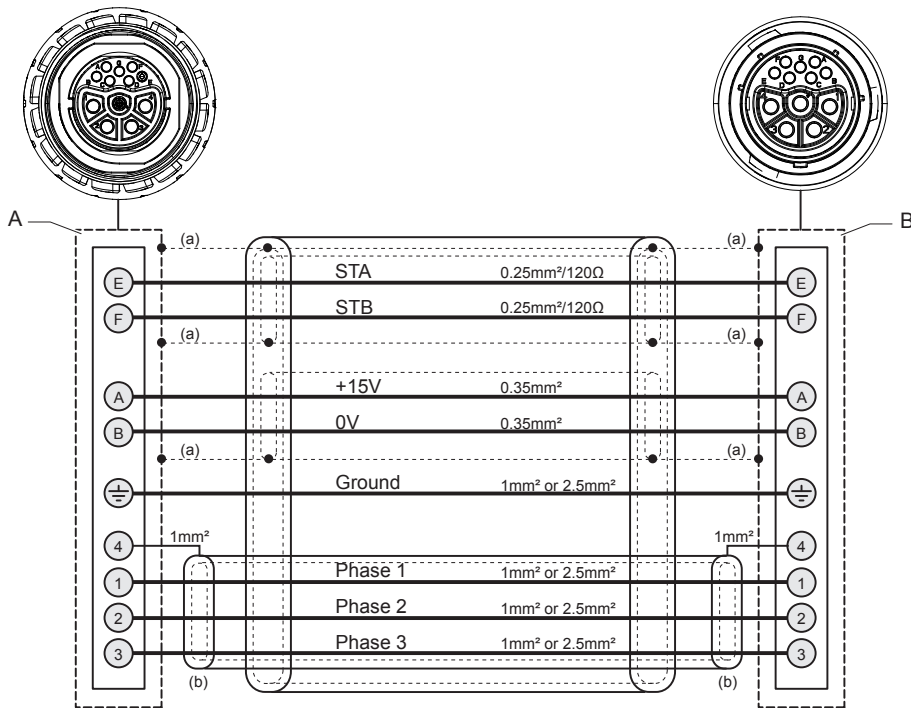

Legend

- A** Connector 12 pts Male
- B** Connector 12 pts Female
- a** Ground shielded cable
- b** **WARNING : Shielded insulate**

STA	Twisted pairs: 2x0.25 mm ²
STB	at 10 MHz 65 Ω

Cable	Color
STA	Red
STB	Red / Blue
+15V	Black / Blue
0V	Black
Ground	Yellow / Green
Phase 1	Black
Phase 2	Brown
Phase 3	Blue

2 - CVI II ADAPTOR

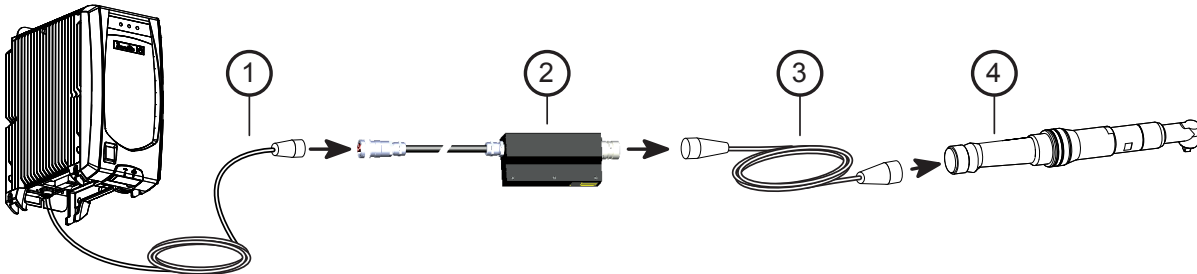

Switch off the controller before disconnecting the tool cable

Legend

- 1** CVI3 extension cable (optional)
- 2** CVI II adaptor
- 3** CVI II cable
- 4** CVI II tool

3 - RS232 - SubD 9pt

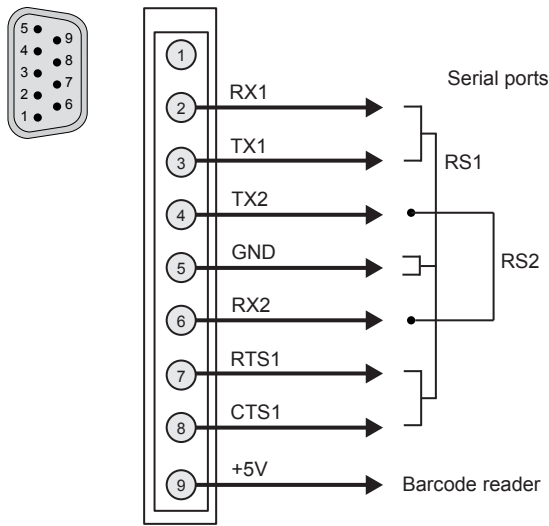

5 - DIGITAL OUTPUTS (0 – 24V)

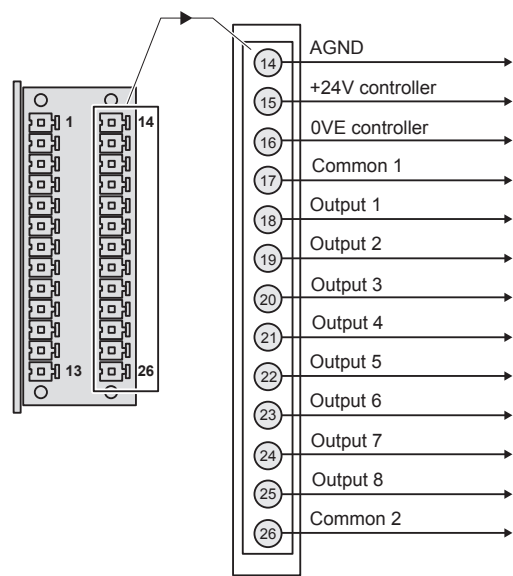

4 - DIGITAL INPUTS (0 – 24V)

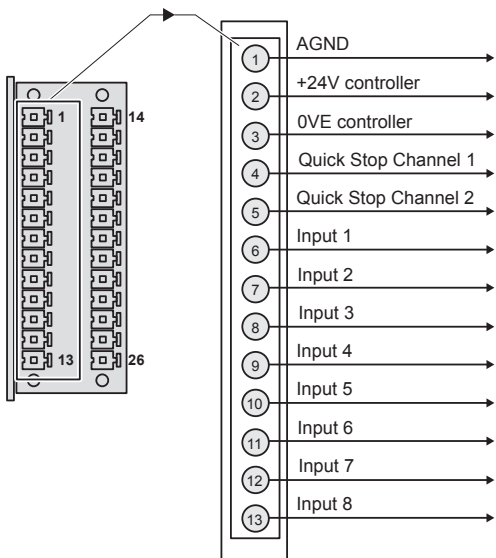

Example of connections:

Possibility to connect a 24V external supply in parallel of the 24V delivered by the controller:

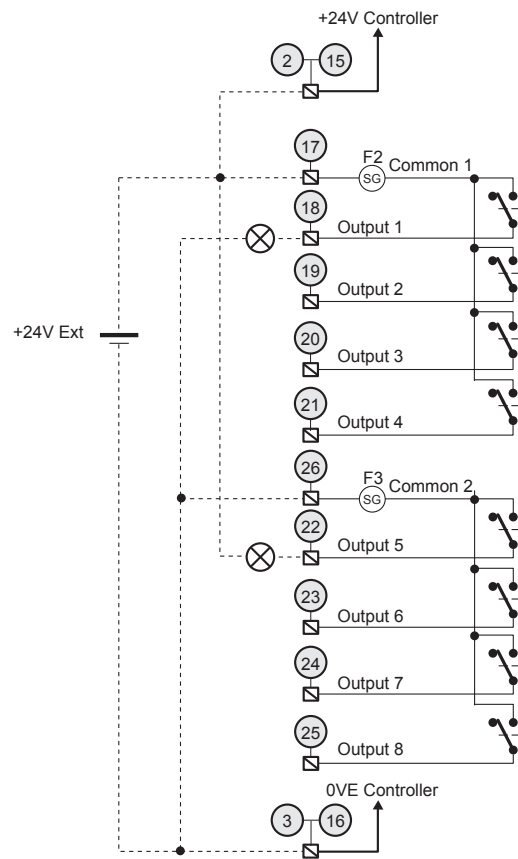

Example of connections:

Possibility to connect a 24V external supply in parallel of the 24V delivered by the controller:

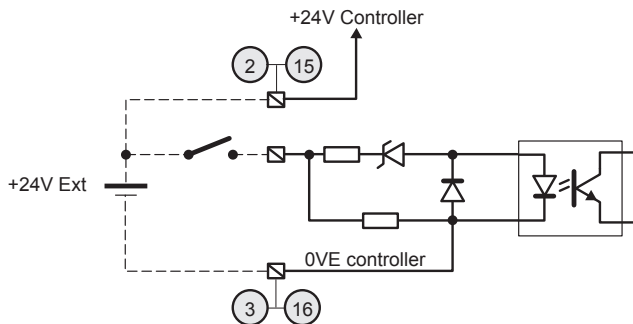

6 - Tightening flow chart and timing chart

Input/Output defined by default can be used to control tightening operation from a PLC or other electronic device. Here is an example of standard exchange between a CVI3 controller and a PLC.

6.1 - Tightening operation through IO flow-chart

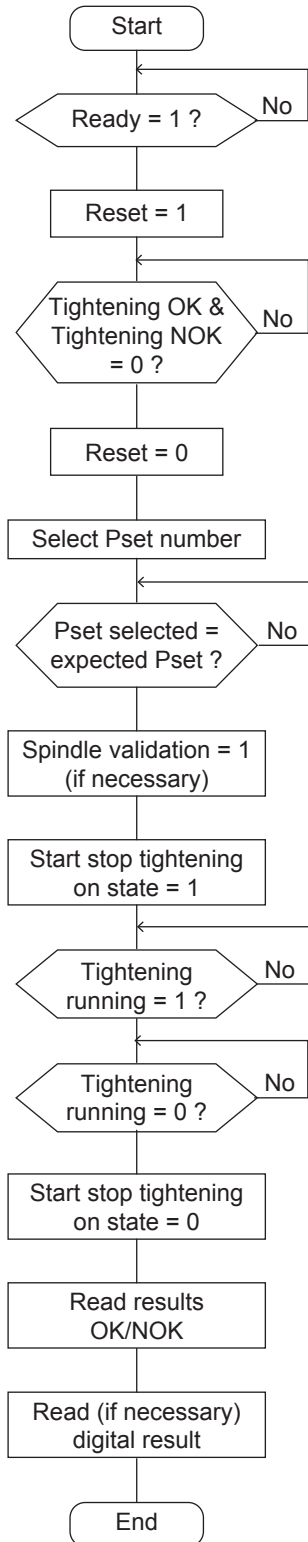

6.2 - Tightening operation through IO timing chart

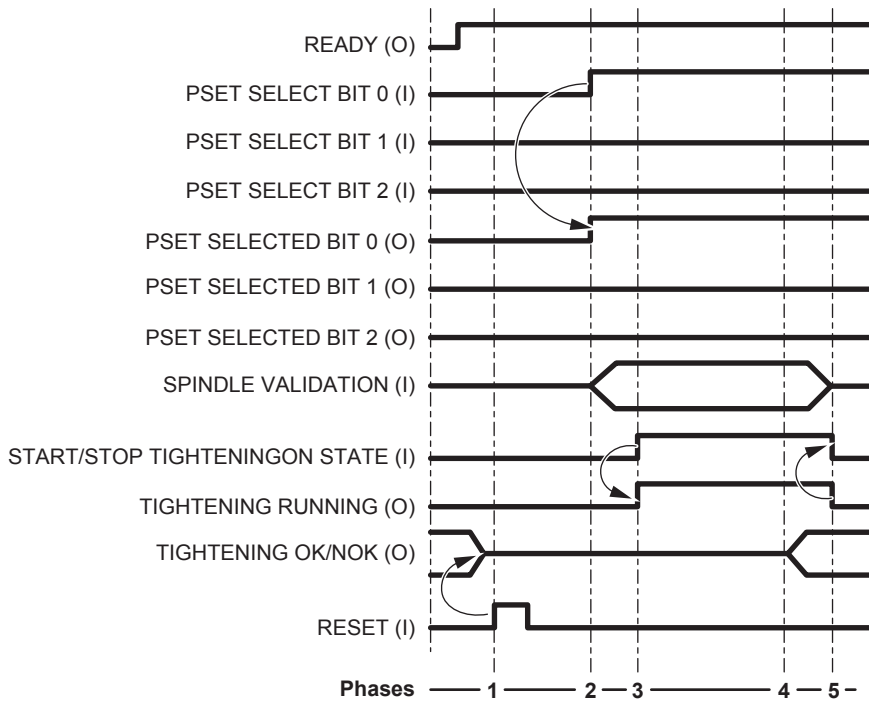

Phase	Designation
1	The "Reset" signal is sent by the PLC. This leads to reset the report ("Tightening OK/NOK").
2	The controller receives the Pset no.1 selection. The command is acknowledged by the "Pset Selected" signals.
3	The controller detects the "Start Stop Tightening On State" signal transition. The tightening operation starts and "Tightening Running" signal is set to 1.
4	At the end of the tightening operation, the controller sets "Tightening OK" or "Tightening NOK" signals.
5	The "Tightening Running" signals returns to zero when all operations are over.

7 - SYNCHRONIZING SINGLE-CHANNEL CONTROLLERS

It is necessary to wire a diode 1N4148 in serial with each synchro out signal.

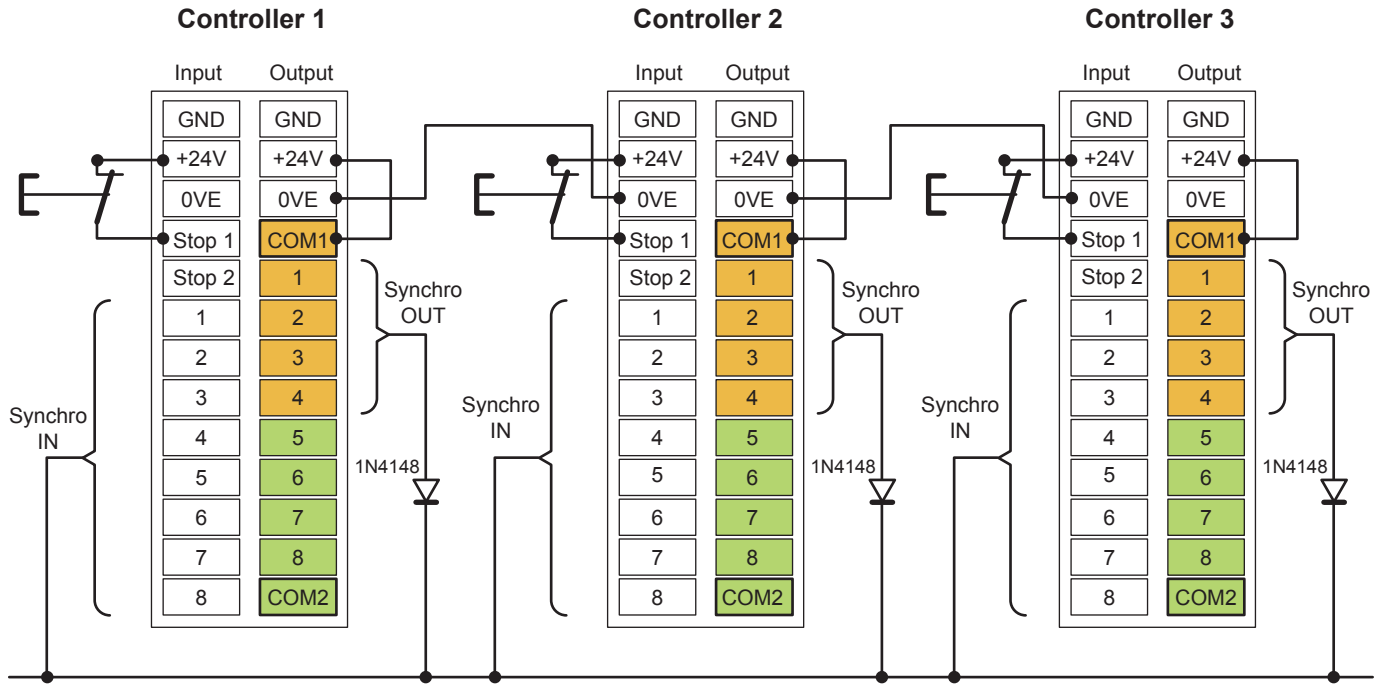

8 - SYNCHRONIZING TWINCVI3 CONTROLLERS

It is necessary to wire a diode 1N4148 in serial with each synchro out signal.

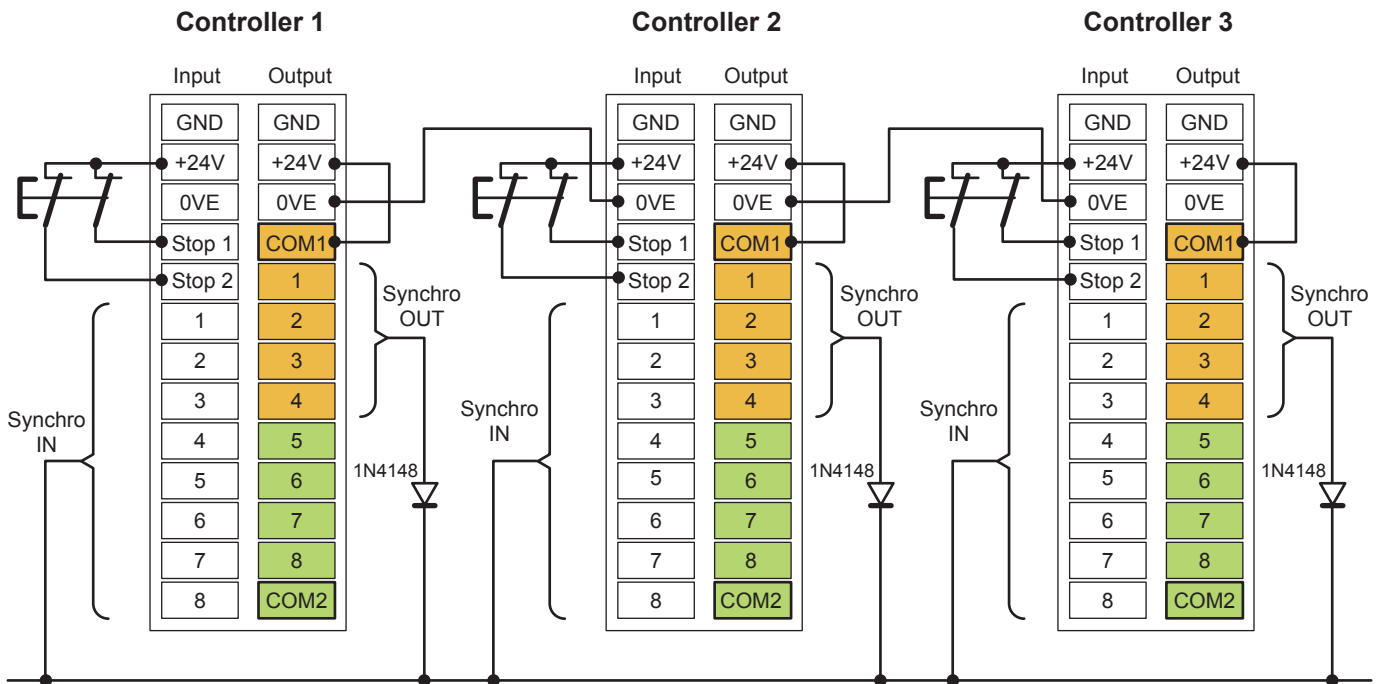

9 - eBUS (for accessories)

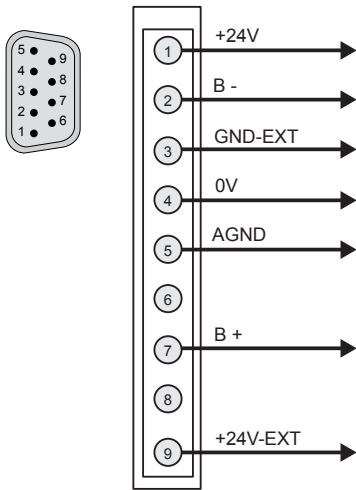

10 - WORKGROUP

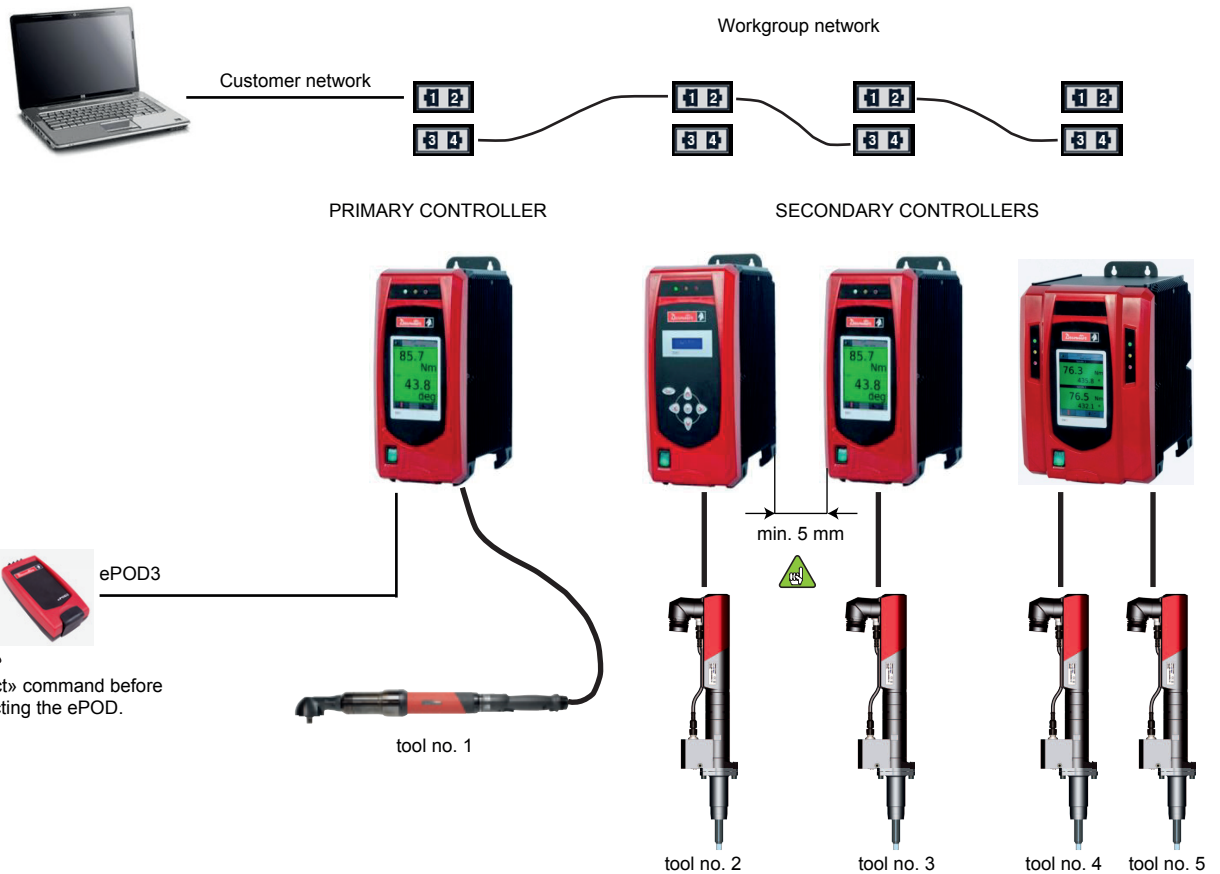

Use «Eject» command before disconnecting the ePOD.

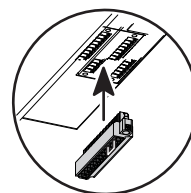

For each secondary controller, check that the quick stop is on but inactive

Appendix - Spare parts - CVI3 FUNCTION

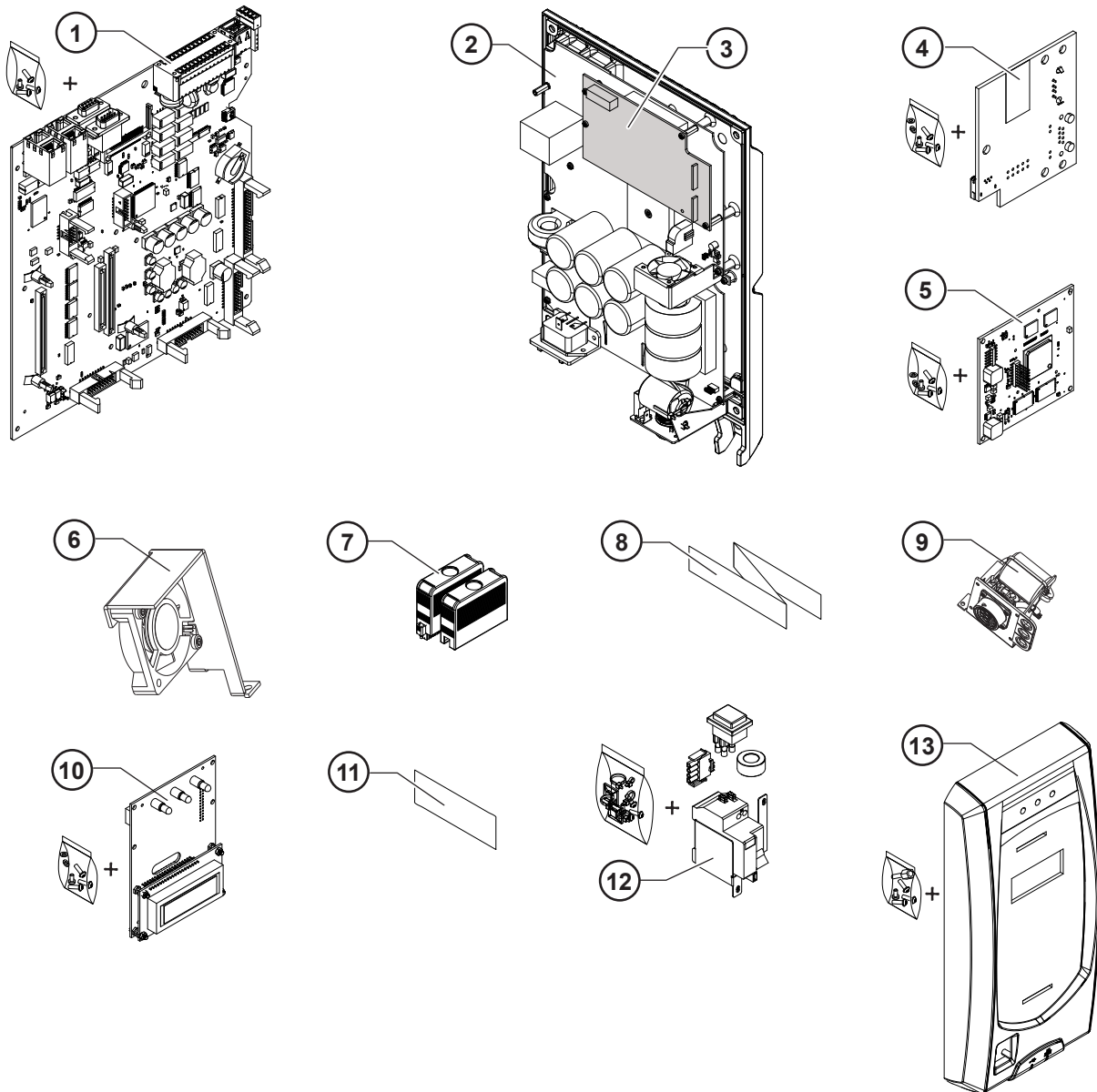

Item	Designation	Part number
1	Interface board including screws	6159188835
2	Complete drive board on the heatsink	6153972145
3	TPLC board	6159188985
4	Ethernet board including screws	6159188825
5	CPU board including screws	6159188895
6	Drive board fan	-
7	I/O connector kit	6159285025
8	Flat cable for Interface board / Drive board connection	6159285065
9	Tool connector kit	-
10	Display board including support and screws	6159188815
11	Warning label	6158715620
12	Earth fault circuit breaker including GFI switch, wiring kit and screws	6159159865
13	Front panel including screws	6155731425

APPENDIX A - CONTROLLER POWER CONSUMPTION: CURRENT INLET

The "Power triangle"

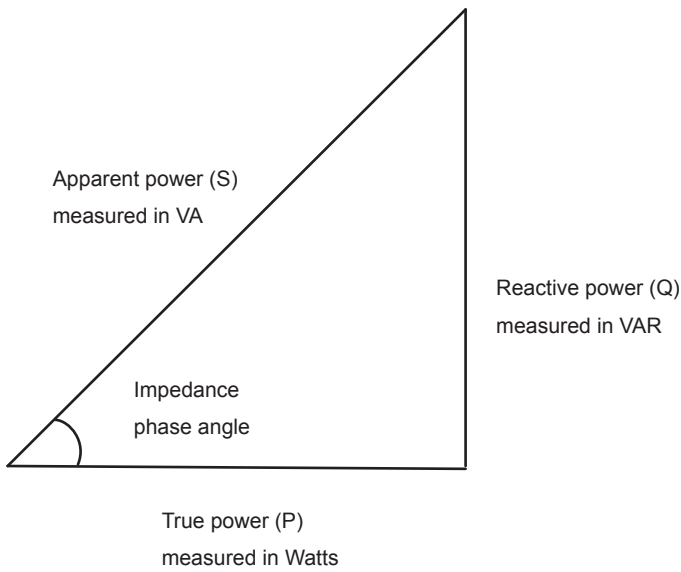

P = true power $P = \frac{1}{T} \int_0^T u(t) \times i(t) dt$ measured in units of Watts

where T is the period of the signal

On a CVI3, the Power peak is 5kW.

To dimension an installation, the apparent power consumption is the only needed information.

S = apparent power

$$S = U_{rms} \times I_{rms}$$

measured in Volt-Amps (VA)

The apparent power peak is 6kVA the duration of the peak is < 0.5 s

The mean apparent power is always ≤ 1 kVA.

SINGLE PHASE 230 V

At 230 V

$$\rightarrow I_{rms} \times \frac{230}{\sqrt{2}} \leq 1 \text{ kVA}$$

$$\rightarrow I_{rms} \leq 1000 \times \frac{\sqrt{2}}{230} \text{ A}$$

$$\rightarrow I_{rms} \leq 6.15 \text{ A}$$

Then we recommend to use a circuit breaker 10A Curve D.

At 110 V

$$\rightarrow I_{rms} \times \frac{110}{\sqrt{2}} \leq 1 \text{ kVA}$$

$$\rightarrow I_{rms} \leq 1000 \times \frac{\sqrt{2}}{110} \text{ A}$$

$$\rightarrow I_{rms} \leq 12.85 \text{ A}$$

Then we recommend to use a circuit breaker 20A Curve D.

APPENDIX B - JVL6-32 RESIDUAL CURRENT CIRCUIT BREAKER

The CVI3 has a JVL6-32 residual current circuit breaker with over-current Protection.

The residual current circuit breaker must be tested monthly.

It provides protection against earth leakage faults (30mA), overloads, short-circuits and Over-current in your installation (I=16A. see curve).

The Over-current protection of the JVL6-32 uses “D” tripping characteristics



FIGURE 1 – CURVE C AND D

APPENDIX - ePOD

The ePOD unlocks a specified level of functionality and acts as a back-up unit for the configuration of the CVI3 controllers. It also increases the number of results, curves and logs in the controller.

There are different models of ePOD and specific ePOD designed for some specific protocols.

Model	ePOD1	ePOD2	ePOD3	ePOD2C	ePOD3C	ePOD4C
Part number	6159360750	6159360760	6159360770	6159363110	6159363180	6159363120
Backup						
Complete backup of the controller system	included	included	included	included	included	included
Results storage						
Number of Pset results	10,000	20,000	20,000	20,000	20,000	20,000
Number of curves per tool	20	50	50	50	50	50
Number of Pset versions per Pset	10	20	20	20	20	20
Number of events in the event log	500	1,000	1,000	1,000	1,000	1,000
Basic functions						
Number of steps per Pset:						
- Tools with cable connection	15	15	40	15	15	40
- Wireless battery tools	10	10	10	10	10	10
CVILOGIX	-	included	included	included	included	included
Workgroup	-	-	included	-	-	included
Programming / Supervision / Controller backup						
Results storage	-	included	included	included	included	included

Tightening units management (with CVI3 Vision controller only)						
Maximum number of tightening units	2	2	2	3	3	4
Maximum number of wireless battery tools	1	1	1	2	3	4

ePOD1

ePOD1 is a backup module for the controller result and configuration database.

- It can be used as real time backup module. In this case the ePOD1 must always be plugged to the controller.
- It also can be used as a manual backup that stores the configuration database, the results database and the firmware version of the controller. ePOD1 gets a snapshot of the controller.

ePOD2

ePOD2 has all functionalities of ePOD1.

- ePOD2 activates CVILOGIX (Embedded PLC of CVI3 controllers).

ePOD3

ePOD3 has all functionalities of ePOD2.

- ePOD3 activates the workgroup configuration.

ePODxC

ePODxC has all functionalities of ePOD2 or ePOD3.

- It can be connected to CVI3 Vision controllers only.

More Than Productivity