

DATI TECNICI / TECHNICAL DATA / TECHNISCHE DATEN  
 CARACTÉRISTIQUES TECHNIQUES / DATOS TÉCNICOS / CARACTERÍSTICAS TÉCNICAS

CV RCV	i	n <sub>1</sub> = 2800 min <sup>-1</sup>			n <sub>1</sub> = 1400 min <sup>-1</sup>			n <sub>1</sub> = 900 min <sup>-1</sup>					
		n <sub>2</sub> mirr <sup>1</sup>	Mn <sub>2</sub> Nm	P <sub>1</sub> kW	n <sub>2</sub> mirr <sup>1</sup>	Mn <sub>2</sub> Nm	P <sub>1</sub> kW	n <sub>2</sub> mirr <sup>1</sup>	Mn <sub>2</sub> Nm	P <sub>1</sub> kW	IEC B5	IEC B14	NEMA
352	3.74	749	262	21	374	314	12.8	241	313	8.2	71-80-90-100-112-132	100-112-132	140-180
	4.56	614	277	18.6	307	332	11.1	197	332	7.1	71-80-90-100-112-132	100-112-132	140-180
	5.11	548	289	17.3	274	346	10.3	176	345	6.6	71-80-90-100-112-132	100-112-132	140-180
	6.22	450	304	14.9	225	364	8.9	145	364	5.7	71-80-90-100-112-132	100-112-132	140-180
	6.93	404	312	13.8	202	374	8.2	130	374	5.3	71-80-90-100-112-132	100-112-132	140-180
	7.51	373	294	12.0	186	352	7.2	120	352	4.6	71-80-90-100-112-132	100-112-132	140-180
	7.78	360	321	12.6	180	384	7.5	116	384	4.8	71-80-90-100-112-132	100-112-132	140-180
	9.14	306	310	10.4	153	370	6.2	98	371	4.0	71-80-90-100-112-132	100-112-132	140-180
	10.18	275	318	9.5	138	381	5.7	88	381	3.7	71-80-90-100-112-132	100-112-132	140-180
	11.43	245	326	8.7	122	391	5.2	79	391	3.4	71-80-90-100-112-132	100-112-132	140-180
	12.62	222	300	7.3	111	360	4.4	71	360	2.8	71-80-90-100-112	100-112	140-180
	15.37	182	316	6.3	91	379	3.8	59	378	2.4	71-80-90-100-112	100-112	140-180
	17.11	164	324	5.8	82	388	3.5	53	388	2.2	71-80-90-100-112	100-112	140-180
	19.21	146	333	5.3	73	399	3.2	46.9	399	2.0	71-80-90-100-112	100-112	140-180
	24.19	116	308	3.9	58	369	2.3	37.2	368	1.5	71-80-90-100-112	100-112	140-180
29.45	95	325	3.4	47.5	390	2.0	30.6	389	1.3	71-80-90-100-112	100-112	140-180	
32.80	85	330	3.1	42.7	396	1.8	27.4	397	1.2	71-80-90-100-112	100-112	140-180	
36.82	76	338	2.8	38.0	403	1.7	24.4	405	1.1	71-80-90-100-112	100-112	140-180	
353	41.20	68	332	2.5	34.0	396	1.5	21.8	397	0.98	63-71-80-90	90	56-140
	46.20	61	339	2.3	30.3	406	1.4	19.5	405	0.89	63-71-80-90	90	56-140
	54.00	52	311	1.8	25.9	372	1.1	16.7	372	0.70	63-71-80-90	90	56-140
	65.80	42.6	326	1.6	21.3	391	0.94	13.7	391	0.60	63-71-80-90	90	56-140
	73.60	38.2	333	1.4	19.1	398	0.86	12.3	400	0.55	63-71-80-90	90	56-140
	82.20	34.1	341	1.3	17.0	408	0.78	10.9	408	0.50	63-71-80-90	90	56-140
	99.30	28.2	314	1.0	14.1	377	0.60	9.1	375	0.38	63-71-80-90	90	56-140
	120.90	23.2	329	0.86	11.6	393	0.51	7.4	392	0.33	63-71-80-90	90	56-140
	134.70	20.8	336	0.79	10.4	400	0.47	6.7	401	0.30	63-71-80-90	90	56-140
	151.10	18.5	344	0.72	9.3	411	0.43	6.0	410	0.28	63-71-80-90	90	56-140
	189.20	14.8	317	0.53	7.4	383	0.32	4.8	381	0.20	63-71-80-90	90	56-140
	230.30	12.2	342	0.47	6.1	408	0.28	3.9	408	0.18	63-71-80-90	90	56-140
	256.50	10.9	357	0.44	5.5	428	0.26	3.5	429	0.17	63-71-80-90	90	56-140
	287.90	9.7	369	0.40	4.9	440	0.24	3.1	442	0.16	63-71-80-90	90	56-140

DIMENSIONI / DIMENSIONS / ABMESSUNGEN / DIMENSIONS / DIMENSIONES / DIMENSÕES

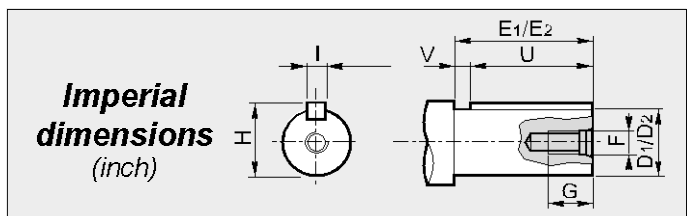
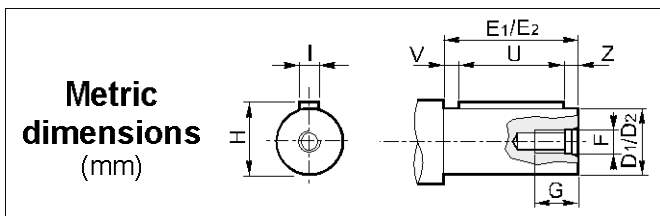

① **Albero entrata / Input shaft / Antriebswelle**  
 Arbre d'entrée / Eje de entrada / Eixo de entrada

CV RCV	D <sub>1</sub> h6	E <sub>1</sub>	F	G	H	I	U	V	Z
352	24	50	M8	18	27	8	40	5	5
353	19	40	M6	15	21.5	6	30	5	5

① **Albero entrata / Input shaft / Antriebswelle**  
 Arbre d'entrée / Eje de entrada / Eixo de entrada

CV	D <sub>1</sub>	E <sub>1</sub>	F	G	H	I	U	V
352	1.000	1.969	5/16-18	0.709	1.109	0.250	1.500	0.469
353	0.750	1.575	5/16-18	0.709	0.832	0.187	1.000	0.575

② **Albero uscita / Output shaft / Abtriebswelle**  
 Arbre de sortie / Eje de salida / Eixo de saída

CV RCV	D <sub>2</sub> h6	E <sub>2</sub>	F	G	H	I	U	V	Z
352 353	28	60	M8	18	31	8	50	5	5
	30	60	M10	22	33	8	50	5	5
	32	80	M10	22	35	10	70	5	5
	35	80	M10	22	38	10	70	5	5
	38	80	M10	22	41	10	70	5	5
	40	80	M12	28	43	12	70	5	5

② **Albero uscita / Output shaft / Abtriebswelle**  
 Arbre de sortie / Eje de salida / Eixo de saída

CV RCV	D <sub>2</sub>	E <sub>2</sub>	F	G	H	I	U	V
352 353	1.375	3.150	3/8-16	0.906	1.513	0.312	2.500	0.650

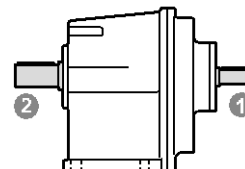

A richiesta / On request / Auf Anfrage / Sur demande / Bajo demanda / Sob consulta

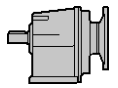

DIMENSIONI / DIMENSIONS / ABMESSUNGEN / DIMENSIONS / DIMENSIONES / DIMENSÕES

**P**

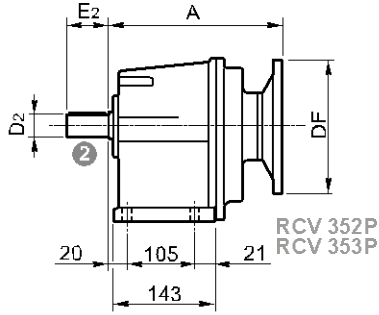

RCV 352P  
RCV 353P

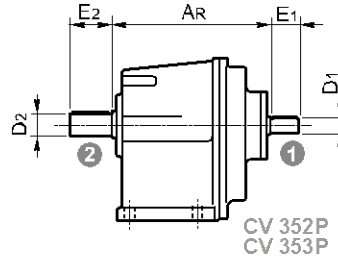

CV 352P  
CV 353P

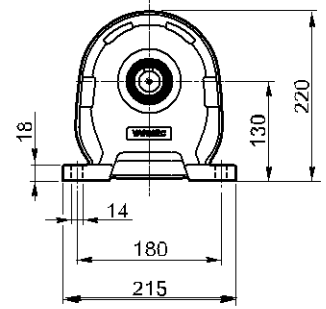

**F**

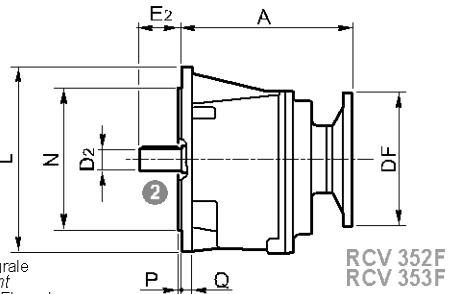

RCV 352F  
RCV 353F

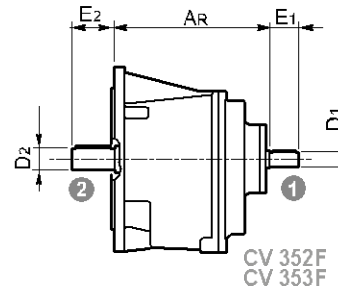

CV 352F  
CV 353F

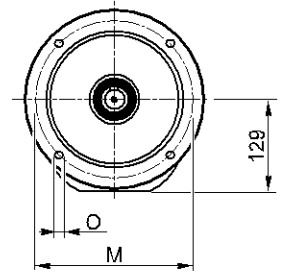

N.B.  
F = Flangia integrale  
F = Flange mount  
F = Integriertem Flansch  
F = Bride monobloc  
F = Brida integral  
F = Brida integral

**N**

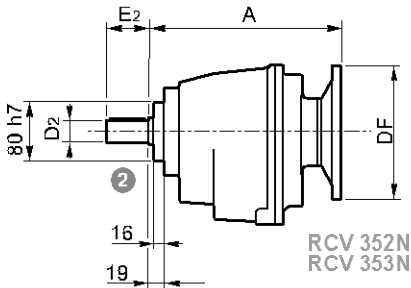

RCV 352N  
RCV 353N

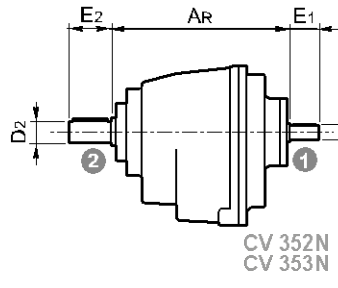

CV 352N  
CV 353N

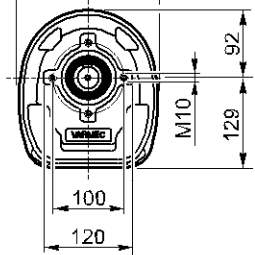

**NF**

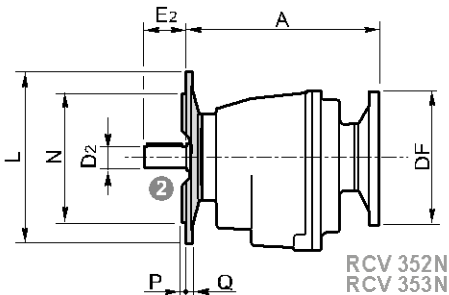

RCV 352NF..  
RCV 353NF..

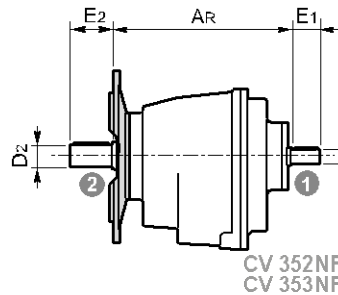

CV 352NF..  
CV 353NF..

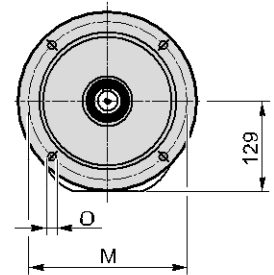

	L	M	N h8	O	P	Q
NF160	160	130	110	11	3.5	11
NF200	200	165	130	13	3.5	11
NF250	250	215	180	14	4	11
F250	250	215	180	14	4	13

**P - F**

RCV CV	RCV							CV
	IEC	DF		A	NEMA	DF	A	
		(B5)	(B14)					
352	71	160		224	140	165.1	234	219
	80	200			180	228.6	240	
	90	200						
	100	250	160					
	112	250	160					
	132	300	200		253			
353	63	140		221	56	165.1	229	214
	71	160			140	165.1	229	
	80	200						
	90	200	140					

**N - NF**

RCV CV	RCV							CV	
	IEC	DF		A	NEMA	DF	A		
		(B5)	(B14)						
352	71	160		249	140	165.1	259	244	
	80	200			180	228.6	265		
	90	200							
	100	250	160						
	112	250	160						
	132	300	200		278				
	353	63	140			246	56		165.1
71		160		140	165.1		254		
80		200							
90		200	140						